

DrillLine



DEEPT^{RI}DRILL

www.tungaloy.com

Tungaloy Report No. 430-G

Deep hole drills for **outstanding productivity**
in a wide range of applications



INDUSTRY 4.0
FEED the SPEED!

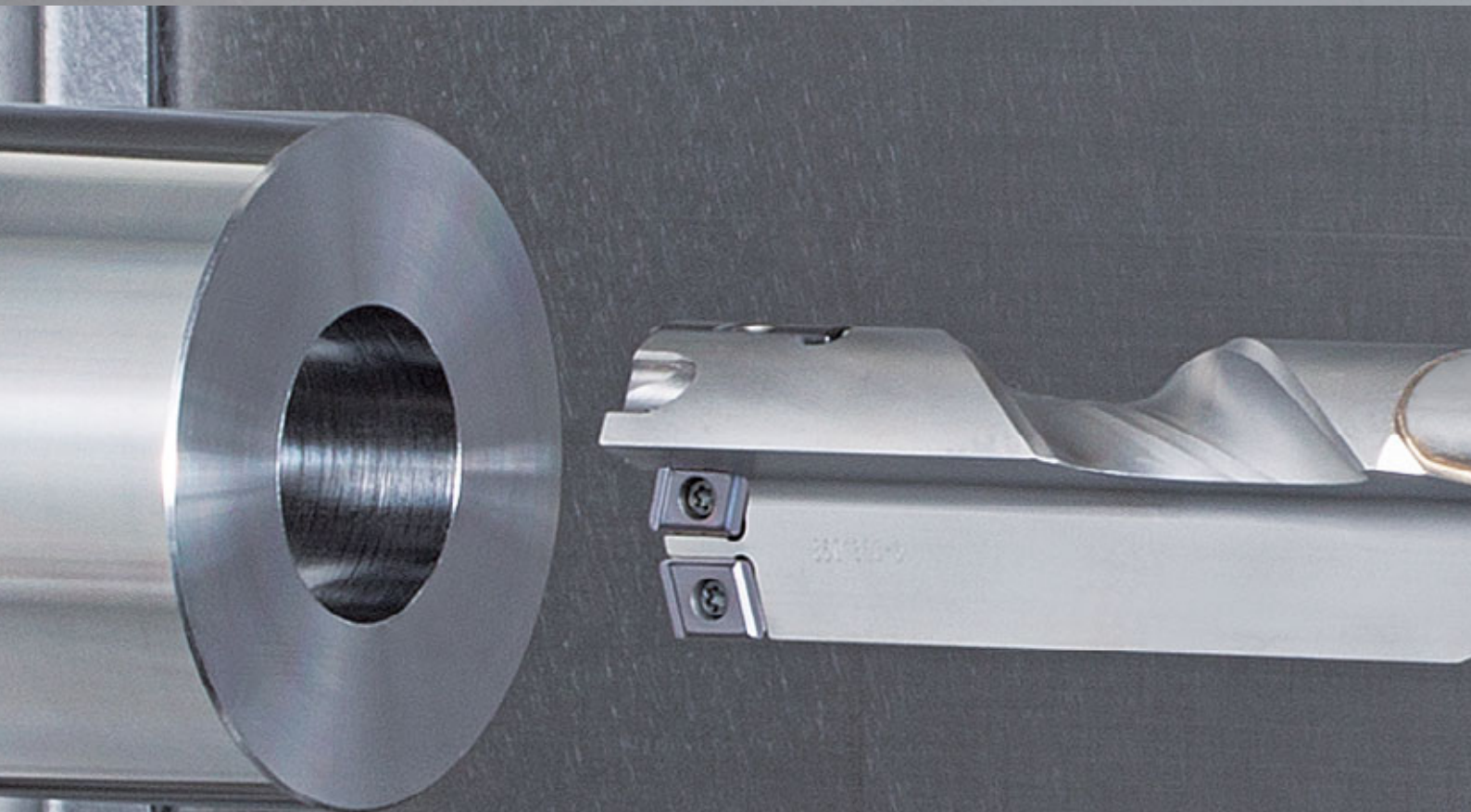
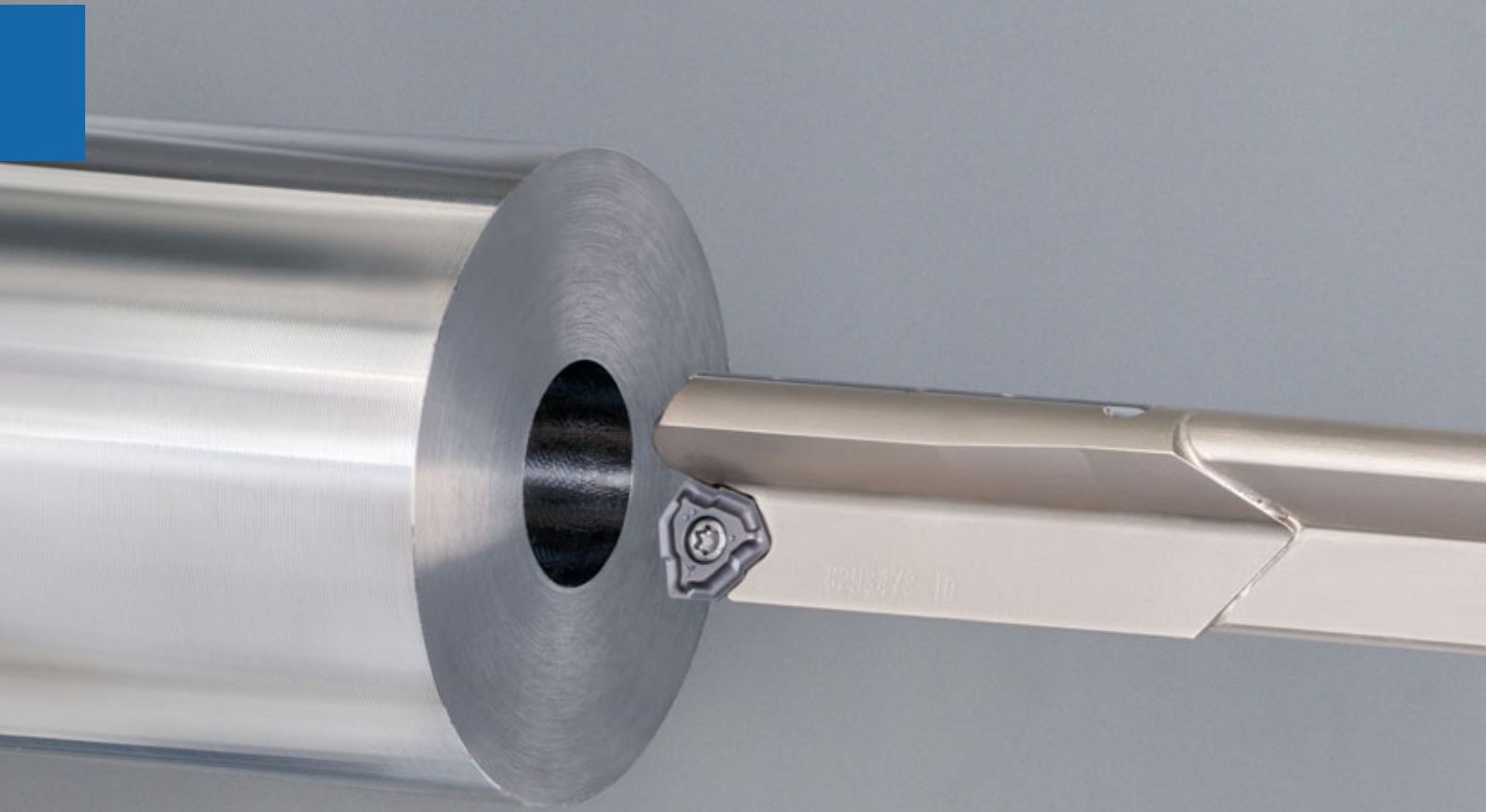

ACCELERATED MACHINING

DrillLine

DEEPT^{RI}DRILL
TUNGALOY



DeepTri-Drill, **the easy-to-handle, indexable gundrill series**, delivers outstanding performance, exceptional efficiency and stability in deep hole drilling

DeepTri-Drill indexable gun drill with exceptional efficiency now offers **smaller diameters**

Wide range of options for various deep hole applications

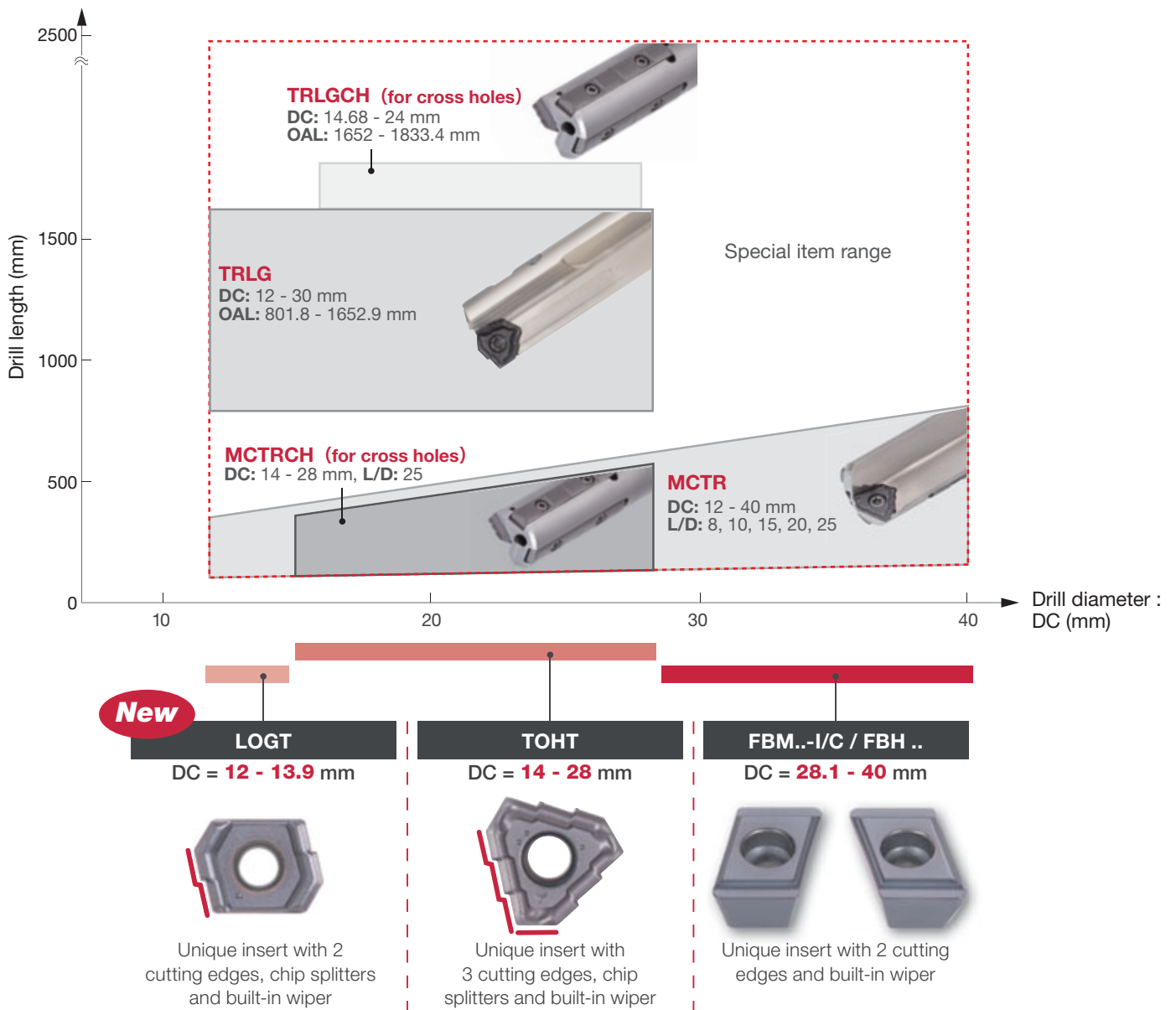

Ultimate efficiency

- Unique **chip breaker** and **chip splitter** on the cutting edge enables impressive chip control at any feed rate, especially at higher feeds

■ Comparison of performance between brazed and indexable gun drills

P S55C / C55

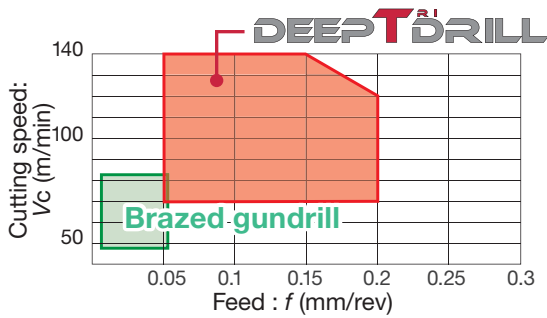

■ Chip forms

P S55C / C55

Drill diameter : DC = 21 mm



Cutting speed : Vc = 100 m/min
Feed : f = 0.15 mm/rev



Vc = 60 m/min
f = 0.05 mm/rev

- Thanks to smooth chip evacuation, deep hole making (drilling) is possible even with a standard coolant pressure of 1-2 MPa (145-290 psi)

Excellent roundness, straightness, and surface finish

Special cutting edge geometry and optimized guide pads provide exceptional hole quality.



Roundness

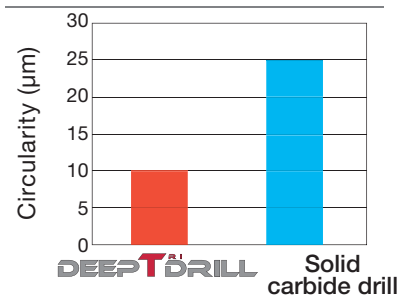

Material : SCM440 / 42CrMo4
Cutting speed : Vc = 100 m/min
Feed : f = 0.2 mm/rev

Straightness

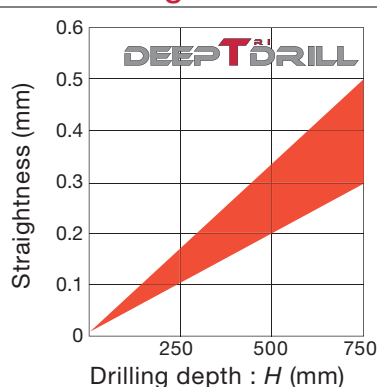

Surface finish

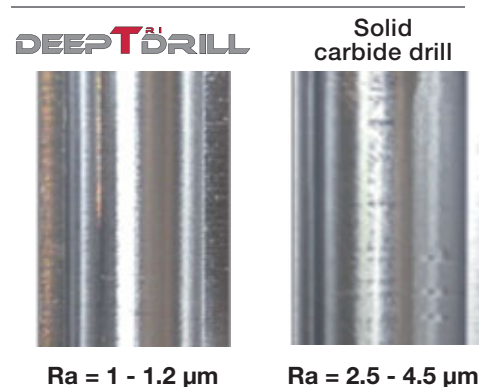

MCTR L/D=8

Drill body for lathes and machining centers, L/D = 8, Tool diameter $\phi 33.1$, $\phi 39.1$ mm

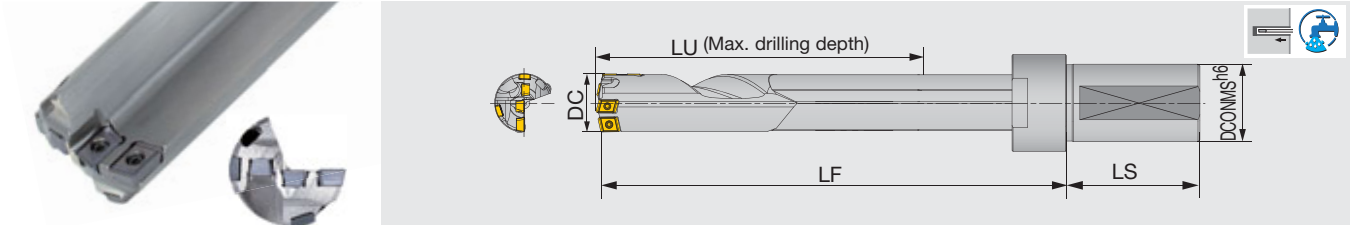

Designation	DC	DCONMS	LU	LS	LF	Insert	Guide pad
MCTR33.10XFM40-8	33.1	40	275	69	350	FBM06**-C, FBM06**-I, FBH07**-P	GP07, GP07-20-120-DC
MCTR39.10XFM40-8	39.1	40	323	69	407	FBM08**-C, FBM06**-I, FBH09**-P	GP08, GP08-25-155-DC

DC	Tool diameter tolerance	Applicable tolerance range of hole diameter
33.1, 39.1	0 / - 0.07	+ 0.05 / - 0.1

Max. DC = 40: Available tailor-made tools

Designation	SPARE PARTS							
	Central		Intermediate		Peripheral		Guide pad	
	Screw	Wrench	Screw	Wrench	Screw	Wrench	Screw	Wrench
MCTR33.1..., MCTR39.1...	CSTB-2.5	T-8F	CSTB-2.5	T-8F	CSTB-2.5	T-8F	CSTB-3S	T-9F

Recommended torque (N·m) for clamping: CSTB2.5=1.3, CSTB-3S=2.3

Note: The drill body surface is blackened for corrosion resistance and may appear uneven. This, however, will not affect the performance of the drill.

MCTR L/D=10

Drill body for lathes and machining centers, L/D = 10, Tool diameter $\phi 16 - \phi 28$ mm

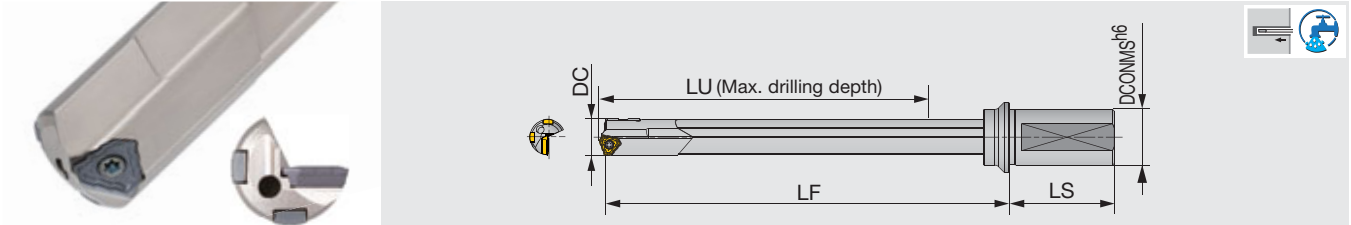

Designation	DC	DCONMS	LU	LS	LF	Insert	Guide pad
MCTR16.00XM25A-10	16	25	172.2	56	209	TOHT08...	GP05-075, GP05-18-075-DC
MCTR16.50XM25A-10	16.5	25	172.2	56	209	TOHT08...	GP05-075, GP05-18-075-DC
MCTR17.00XM25A-10	17	25	182.2	56	220	TOHT08...	GP05-075, GP05-18-075-DC
MCTR17.45XU25.4A-10	17.45	25.4	182.2	56	220	TOHT08..	GP05-075, GP05-18-075-DC
MCTR18.00XM25A-10	18	25	192.2	56	232	TOHT08...	GP05-075, GP05-18-075-DC
MCTR18.24XU25.4-10	18.24	25.4	193	56	232	TOHT09..	GP06-085, GP06-20-085-DC
MCTR18.64XU25.4-10	18.64	25.4	193	56	232	TOHT09..	GP06-085, GP06-20-085-DC
MCTR19.00XM25-10	19	25	203	56	243	TOHT09...	GP06-085, GP06-20-085-DC
MCTR19.05XU25.4-10	19.05	25.4	203	56	243	TOHT09..	GP06-085, GP06-20-085-DC
MCTR19.94XU31.75-10	19.94	31.75	213	60	255	TOHT09..	GP06-085, GP06-20-085-DC
MCTR20.00XM32-10	20	32	213	60	255	TOHT09...	GP06-085, GP06-20-085-DC
MCTR20.62XU31.75-10	20.62	31.75	213.2	60	255	TOHT10..	GP06-085, GP06-20-085-DC
MCTR21.00XM32-10	21	32	223.2	60	266	TOHT10...	GP06-085, GP06-20-085-DC
MCTR22.00XM32-10	22	32	233.4	60	278	TOHT11...	GP06-100, GP06-20-100-DC
MCTR22.23XU31.75-10	22.23	31.75	233.4	60	278	TOHT11...	GP06-100, GP06-20-100-DC
MCTR23.00XM32-10	23	32	243.4	60	289	TOHT11...	GP06-100, GP06-20-100-DC
MCTR23.80XU31.75-10	23.8	31.75	253.4	60	301	TOHT11..	GP06-100, GP06-20-100-DC
MCTR24.00XM32-10	24	32	253.4	60	301	TOHT11...	GP06-100, GP06-20-100-DC
MCTR25.00XM32-10	25	32	263.4	60	312	TOHT11...	GP06-100, GP06-20-100-DC
MCTR25.40XU31.75-10	25.4	31.75	263.7	60	312	TOHT12..	GP06, GP06-20-120-DC
MCTR26.00XM40-10	26	40	273.7	70	324	TOHT12...	GP06, GP06-20-120-DC
MCTR26.97XU31.75X-10	26.97	31.75	283.7	60	335	TOHT12..	GP06, GP06-20-120-DC
MCTR27.00XM40-10	27	40	283.7	70	335	TOHT12...	GP06, GP06-20-120-DC
MCTR28.00XM40-10	28	40	283.7	70	337	TOHT12...	GP06, GP06-20-120-DC

DC	Tool diameter tolerance	Applicable tolerance range of hole diameter
16 - 28	0 / - 0.07	+ 0.05 / - 0.1

SPARE PARTS

Designation	Insert		Guide pad	
	Screw	Wrench	Screw	Wrench
MCTR16... - MCTR20.00...	SR14-560/S	T-8F	SR34-508	T-7F
MCTR20.62... - MCTR21...	SR34-506	T-9F	SR34-508	T-7F
MCTR22... - MCTR25.00...	SR14-571/S	T-10/5	SR34-508	T-7F
MCTR25.4... - MCTR28...	SR14-506	T-15F	SR34-508	T-7F

Recommended torque (N·m) for clamping: SR34-506=0.9, SR34-508=0.9, SR14-560/S=1.2, SR14-571/S=3.2, SR14-506=4.8

Reference pages: Inserts → [P.23](#), Guide pads → [P.25](#)

MCTR-F L/D=10

Drill body for lathes and machining centers, L/D = 10, Tool diameter $\phi 28.58 - \phi 40$ mm

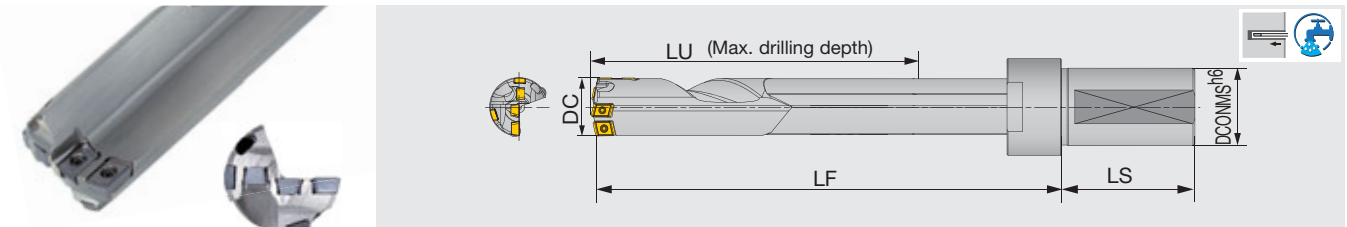

Designation	DC	DCONMS	LU	LS	LF	Insert	Guide pad
MCTR28.58XFU31.75-10	28.58	31.75	292.6	69	360	FBM06**-C, FBM055/060**-I, FBH06**-P	GP06, GP06-20-120-DC
MCTR29.00XFM40-10	29	40	292.6	69	360	FBM06**-C, FBM055/060**-I, FBH06**-P	GP06, GP06-20-120-DC
MCTR30.00XFM40-10	30	40	312.9	69	383	FBM06**-C, FBM065/070**-I, FBH07**-P	GP06, GP06-20-120-DC
MCTR31.00XFM40-10	31	40	312.9	69	383	FBM06**-C, FBM065/070**-I, FBH07**-P	GP06, GP06-20-120-DC
MCTR31.75XFU31.75-10	31.75	31.75	323	69	395	FBM06**-C, FBM065/070**-I, FBH07**-P	GP06, GP06-20-120-DC
MCTR32.00XFM40-10	32	40	323	69	395	FBM06**-C, FBM065/070**-I, FBH07**-P	GP06, GP06-20-120-DC
MCTR33.00XFM40-10	33	40	333.1	69	406	FBM06**-C, FBM065/070**-I, FBH07**-P	GP06, GP06-20-120-DC
MCTR34.00XFM40-10	34	40	343	69	418	FBM06**-C, FBM065/070**-I, FBH07**-P	GP07, GP07-20-120-DC
MCTR34.93XFU31.75-10	34.93	31.75	353.1	69	428	FBM06**-C, FBM065/070**-I, FBH07**-P	GP07, GP07-20-120-DC
MCTR35.00XFM40-10	35	40	353.1	69	428	FBM06**-C, FBM065/070**-I, FBH07**-P	GP07, GP07-20-120-DC
MCTR36.00XFM40-10	36	40	363.1	69	441	FBM08**-C, FBM065/070**-I, FBH07**-P	GP07, GP07-20-120-DC
New MCTR37.00XFM40-10	37	40	373	69	451	FBM08**-C, FBM065/070**-I, FBH07**-P	GP07, GP07-20-120-DC
New MCTR38.00XFM40-10	38	40	383.1	69	464	FBM08**-C, FBM065/070**-I, FBH07**-P	GP07, GP07-20-120-DC
MCTR38.10XFU31.75-10	38.1	31.75	393.4	69	474	FBM08**-C, FBM065/070**-I, FBH09**-P	GP08, GP08-25-155-DC
New MCTR39.00XFM40-10	39	40	393.4	69	474	FBM08**-C, FBM065/070**-I, FBH09**-P	GP08, GP08-25-155-DC
New MCTR40.00XFM40-10	40	40	403.3	69	487	FBM08**-C, FBM065/070**-I, FBH09**-P	GP08, GP08-25-155-DC

DC	Tool diameter tolerance	Applicable tolerance range of hole diameter
28.58 - 40	0 / - 0.07	+ 0.05 / - 0.1

SPARE PARTS

Designation	Insert						Guide pad	
	Central		Intermediate		Peripheral		Screw	Wrench
	Screw	Wrench	Screw	Wrench	Screw	Wrench		
MCTR28.58... - MCTR29...	CSTB-2.5	T-8F	CSTB-2.2	T-7F	CSTB-2.2	T-7F	SR34-508	T-7F
MCTR30... - MCTR33...	CSTB-2.5	T-8F	CSTB-2.5	T-8F	CSTB-2.5	T-8F	SR34-508	T-7F
MCTR34... - MCTR40...	CSTB-2.5	T-8F	CSTB-2.5	T-8F	CSTB-2.5	T-8F	CSTB-3S	T-9F

Recommended torque (N·m) for clamping: SR34-508=0.9, CSTB-2.2=1, CSTB-2.5=1.3, CSTB-3S=2.3,

Note: The drill body surface is blackened for corrosion resistance and may appear uneven. This, however, will not affect the performance of the drill.

Reference pages: Inserts → [P.24](#), Guide pads → [P.25](#)

MCTR L/D=15

Drill body for lathes and machining centers, L/D = 15, Tool diameter $\phi 12 - \phi 28$ mm

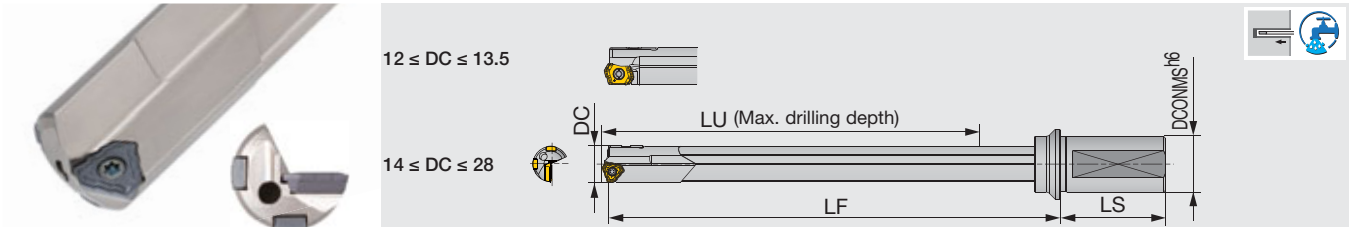

Designation	DC	DCONMS	LU	LS	LF	Insert	Guide pad
MCTR12.00XM20-15	12	20	196.8	50	225	LOGT06...	GP04-055, GP04-16-055-DC
MCTR12.50XM20-15	12.5	20	196.8	50	226	LOGT06...	GP04-055, GP04-16-055-DC
MCTR12.70XU25.4-15	12.7	25.4	196.8	56	229	LOGT06..	GP04-055, GP04-16-055-DC
MCTR13.00XM25-15	13	25	211.8	56	245	LOGT06...	GP04-055, GP04-16-055-DC
MCTR13.49XU25.4-15	13.49	25.4	211.8	56	245	LOGT06..	GP04-055, GP04-16-055-DC
MCTR13.50XM25-15	13.5	25	211.8	56	245	LOGT06...	GP04-055, GP04-16-055-DC
MCTR14.00XM25-15	14	25	227	56	245	TOHT07...	GP05-060, GP05-18-060-DC
MCTR14.27XU25.4-15	14.27	25.4	227	56	261	TOHT07..	GP05-060, GP05-18-060-DC
MCTR14.50XM25-15	14.5	25	227	56	262	TOHT07...	GP05-060, GP05-18-060-DC
MCTR15.00XM25-15	15	25	242	56	278	TOHT07...	GP05-060, GP05-18-060-DC
MCTR15.88XU25.4-15	15.88	25.4	242	56	279	TOHT07..	GP05-060, GP05-18-060-DC
MCTR16.00XM25A-15	16	25	257.2	56	294	TOHT08...	GP05-075, GP05-18-075-DC
MCTR16.50XM25A-15	16.5	25	257.2	56	294	TOHT08...	GP05-075, GP05-18-075-DC
MCTR17.00XM25A-15	17	25	272.2	56	310	TOHT08...	GP05-075, GP05-18-075-DC
MCTR17.45XU25.4A-15	17.45	25.4	272.2	56	310	TOHT08..	GP05-075, GP05-18-075-DC
MCTR17.50XM25A-15	17.5	25	272.2	56	310	TOHT08...	GP05-075, GP05-18-075-DC
MCTR18.00XM25A-15	18	25	287.2	56	327	TOHT08...	GP05-075, GP05-18-075-DC
MCTR18.24XU25.4-15	18.24	25.4	288	56	327	TOHT09..	GP06-085, GP06-20-085-DC
MCTR18.50XM25-15	18.5	25	288	56	327	TOHT09...	GP06-085, GP06-20-085-DC
MCTR18.64XU25.4-15	18.64	25.4	288	56	327	TOHT09..	GP06-085, GP06-20-085-DC
MCTR19.00XM25-15	19	25	303	56	343	TOHT09...	GP06-085, GP06-20-085-DC
MCTR19.05XU25.4-15	19.05	25.4	303	56	343	TOHT09..	GP06-085, GP06-20-085-DC
MCTR19.50XM25-15	19.5	25	303	56	343	TOHT09...	GP06-085, GP06-20-085-DC
MCTR19.94XU31.75-15	19.94	31.75	318	60	360	TOHT09..	GP06-085, GP06-20-085-DC
MCTR20.00XM32-15	20	32	318	60	360	TOHT09...	GP06-085, GP06-20-085-DC
MCTR20.62XU31.75-15	20.62	31.75	318.2	60	360	TOHT10..	GP06-085, GP06-20-085-DC
MCTR21.00XM32-15	21	32	333.2	60	376	TOHT10...	GP06-085, GP06-20-085-DC
MCTR22.00XM32-15	22	32	348.4	60	393	TOHT11...	GP06-100, GP06-20-100-DC
MCTR22.23XU31.75-15	22.23	31.75	348.4	60	393	TOHT11..	GP06-100, GP06-20-100-DC
MCTR23.00XM32-15	23	32	363.4	60	409	TOHT11...	GP06-100, GP06-20-100-DC
MCTR23.80XU31.75-15	23.8	31.75	378.4	60	426	TOHT11..	GP06-100, GP06-20-100-DC
MCTR24.00XM32-15	24	32	378.4	60	426	TOHT11...	GP06-100, GP06-20-100-DC
MCTR25.00XM32-15	25	32	393.4	60	442	TOHT11...	GP06-100, GP06-20-100-DC
MCTR25.40XU31.75-15	25.4	31.75	393.7	60	442	TOHT12..	GP06, GP06-20-120-DC
MCTR26.00XM40-15	26	40	408.7	70	459	TOHT12...	GP06, GP06-20-120-DC
MCTR26.97XU31.75X-15	26.97	31.75	423.7	60	475	TOHT12..	GP06, GP06-20-120-DC
MCTR27.00XM40-15	27	40	423.7	70	475	TOHT12...	GP06, GP06-20-120-DC
MCTR28.00XM40-15	28	40	423.7	70	477	TOHT12...	GP06, GP06-20-120-DC

DC	Tool diameter tolerance	Applicable tolerance range of hole diameter
12 - 28	0 / - 0.07	+ 0.05 / - 0.1

SPARE PARTS



Designation	Insert		Guide pad	
	Screw	Wrench	Screw	Wrench
MCTR12... - MCTR13.5...	SR10503833L040	T-7F	CSPB-2L043	IP-6F
MCTR14... - MCTR20.00...	SR14-560/S	T-8F	SR34-508	T-7F
MCTR20.62... - MCTR21...	SR34-506	T-9F	SR34-508	T-7F
MCTR22... - MCTR25.00...	SR14-571/S	T-10/5	SR34-508	T-7F
MCTR25.4... - MCTR28...	SR14-506	T-15F	SR34-508	T-7F

Recommended torque (N·m) for clamping: CSPB-2L043=0.7, SR34-506=0.9, SR34-508=0.9, SR14-560/S=1.2, SR10503833L040=1.3, SR14-571/S=3.2, SR14-506=4.8

MCTR-F L/D=15

Drill body for lathes and machining centers, L/D = 15, Tool diameter $\varnothing 28.58 - \varnothing 40$ mm

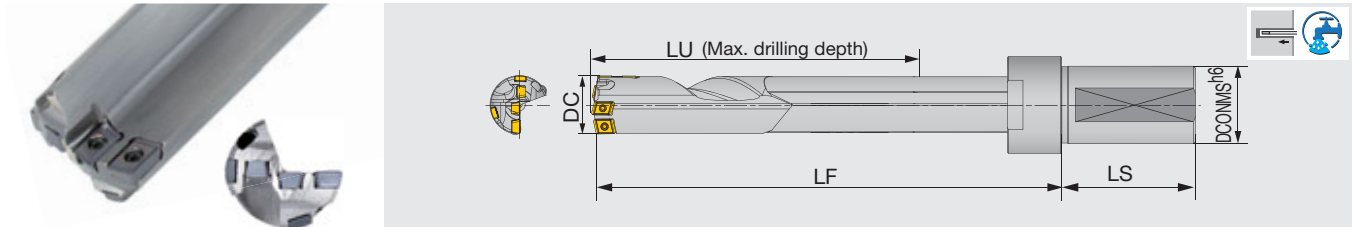

Designation	DC	DCONMS	LU	LS	LF	Insert	Guide pad
MCTR28.58XFU31.75-15	28.58	31.75	437.6	69	505	FBM06**-C, FBM055/060**-I, FBH06**-P	GP06, GP06-20-120-DC
MCTR29.00XFM40-15	29	40	437.6	69	505	FBM06**-C, FBM055/060**-I, FBH06**-P	GP06, GP06-20-120-DC
MCTR30.00XFM40-15	30	40	467.9	69	538	FBM06**-C, FBM065/070**-I, FBH07**-P	GP06, GP06-20-120-DC
MCTR31.00XFM40-15	31	40	467.9	69	538	FBM06**-C, FBM065/070**-I, FBH07**-P	GP06, GP06-20-120-DC
MCTR31.75XFU31.75-15	31.75	31.75	483	69	555	FBM06**-C, FBM065/070**-I, FBH07**-P	GP06, GP06-20-120-DC
MCTR32.00XFM40-15	32	40	483	69	555	FBM06**-C, FBM065/070**-I, FBH07**-P	GP06, GP06-20-120-DC
MCTR33.00XFM40-15	33	40	498.1	69	571	FBM06**-C, FBM065/070**-I, FBH07**-P	GP06, GP06-20-120-DC
MCTR34.00XFM40-15	34	40	513	69	588	FBM06**-C, FBM065/070**-I, FBH07**-P	GP07, GP07-20-120-DC
MCTR34.93XFU31.75-15	34.93	31.75	528.1	69	603	FBM06**-C, FBM065/070**-I, FBH07**-P	GP07, GP07-20-120-DC
MCTR35.00XFM40-15	35	40	528.1	69	603	FBM06**-C, FBM065/070**-I, FBH07**-P	GP07, GP07-20-120-DC
MCTR36.00XFM40-15	36	40	543.1	69	621	FBM08**-C, FBM065/070**-I, FBH07**-P	GP07, GP07-20-120-DC
New MCTR37.00XFM40-15	37	40	558	69	636	FBM08**-C, FBM065/070**-I, FBH07**-P	GP07, GP07-20-120-DC
New MCTR38.00XFM40-15	38	40	573.1	69	654	FBM08**-C, FBM065/070**-I, FBH07**-P	GP07, GP07-20-120-DC
MCTR38.10XFU31.75-15	38.1	31.75	588.4	69	669	FBM08**-C, FBM065/070**-I, FBH09**-P	GP08, GP08-25-155-DC
New MCTR39.00XFM40-15	39	40	588.4	69	669	FBM08**-C, FBM065/070**-I, FBH09**-P	GP08, GP08-25-155-DC
New MCTR40.00XFM40-15	40	40	603.3	69	687	FBM08**-C, FBM065/070**-I, FBH09**-P	GP08, GP08-25-155-DC

DC	Tool diameter tolerance	Applicable tolerance range of hole diameter
28.58 - 40	0 / - 0.07	+ 0.05 / - 0.1

SPARE PARTS

Designation	Insert						Guide pad	
	Central		Intermediate		Peripheral		Screw	Wrench
	Screw	Wrench	Screw	Wrench	Screw	Wrench		
MCTR28.58... - MCTR29...	CSTB-2.5	T-8F	CSTB-2.2	T-7F	CSTB-2.2	T-7F	SR34-508	T-7F
MCTR30... - MCTR33...	CSTB-2.5	T-8F	CSTB-2.5	T-8F	CSTB-2.5	T-8F	SR34-508	T-7F
MCTR34... - MCTR40...	CSTB-2.5	T-8F	CSTB-2.5	T-8F	CSTB-2.5	T-8F	CSTB-3S	T-9F

Recommended torque (N·m) for clamping: SR34-508=0.9, CSTB-2.2=1, CSTB-2.5=1.3, CSTB-3S=2.3

Note: The drill body surface is blackened for corrosion resistance and may appear uneven. This, however, will not affect the performance of the drill.

Reference pages: Inserts → [P.24](#), Guide pads → [P.25](#)

MCTR L/D=20

Drill body for lathes and machining centers, L/D = 20, Tool diameter $\phi 12 - \phi 15$ mm

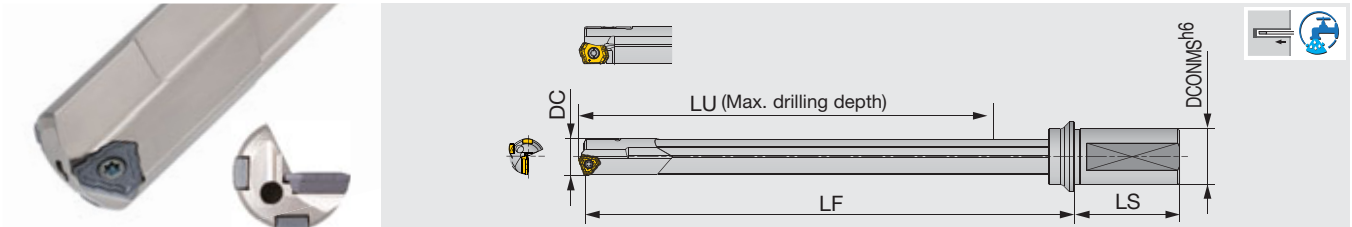

Designation	DC	DCONMS	LU	LS	LF	Insert	Guide pad
MCTR12.00XM20-20	12	20	261.8	50	290	LOGT06...	GP04-055, GP04-16-055-DC
MCTR12.50XM20-20	12.5	20	261.8	50	291	LOGT06...	GP04-055, GP04-16-055-DC
MCTR13.00XM25-20	13	25	281.8	56	315	LOGT06...	GP04-055, GP04-16-055-DC
MCTR13.50XM25-20	13.5	25	281.8	56	315	LOGT06...	GP04-055, GP04-16-055-DC
MCTR14.00XM25-20	14	25	302	56	336	TOHT07...	GP05-060, GP05-18-060-DC
MCTR14.50XM25-20	14.5	25	302	56	337	TOHT07...	GP05-060, GP05-18-060-DC
MCTR15.00XM25-20	15	25	322	56	358	TOHT07...	GP05-060, GP05-18-060-DC

ϕDc	Tool diameter tolerance	Applicable tolerance range of hole diameter
12 - 15	0 / - 0.07	+ 0.05 / - 0.1

SPARE PARTS

Designation	Insert		Guide pad	
	Screw	Wrench	Screw	Wrench
MCTR12...-MCTR13.5...	SR10503833L040	T-7F	CSPB-2L043	IP-6F
MCTR14...-MCTR15...	SR14-560/S	T-8F	SR34-508	T-7F

Recommended torque (N·m) for clamping: CSPB-2L043=0.7, SR34-508=0.9, SR14-560/S=1.2, SR10503833L040=1.3

MCTR L/D=25

Drill body for lathes and machining centers, L/D = 25, Tool diameter $\phi 12 - \phi 28$ mm

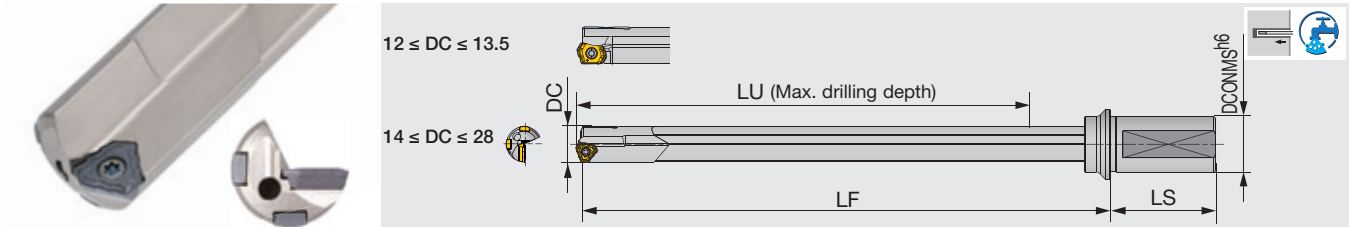

Designation	DC	DCONMS	LU	LS	LF	Insert	Guide pad
MCTR12.00XM20-25	12	20	326.8	50	355	LOGT06...	GP04-055, GP04-16-055-DC
MCTR12.50XM20-25	12.5	20	326.8	50	356	LOGT06...	GP04-055, GP04-16-055-DC
MCTR12.70XU25.4-25	12.7	25.4	326.8	56	359	LOGT06..	GP04-055, GP04-16-055-DC
MCTR13.00XM25-25	13	25	351.8	56	385	LOGT06...	GP04-055, GP04-16-055-DC
MCTR13.49XU25.4-25	13.49	25.4	351.8	56	385	LOGT06..	GP04-055, GP04-16-055-DC
MCTR13.50XM25-25	13.5	25	351.8	56	385	LOGT06...	GP04-055, GP04-16-055-DC
MCTR14.00XM25-25	14	25	377	56	411	TOHT07...	GP05-060, GP05-18-060-DC
MCTR14.27XU25.4-25	14.27	25.4	377	56	411	TOHT07..	GP05-060, GP05-18-060-DC
MCTR14.50XM25-25	14.5	25	377	56	412	TOHT07...	GP05-060, GP05-18-060-DC
MCTR15.00XM25-25	15	25	402	56	438	TOHT07...	GP05-060, GP05-18-060-DC
MCTR15.88XU25.4-25	15.88	25.4	402	56	439	TOHT07..	GP05-060, GP05-18-060-DC
MCTR16.00XM25A-25	16	25	427.2	56	464	TOHT08...	GP05-075, GP05-18-075-DC
MCTR16.50XM25A-25	16.5	25	427.2	56	464	TOHT08...	GP05-075, GP05-18-075-DC
MCTR17.00XM25A-25	17	25	452.2	56	490	TOHT08...	GP05-075, GP05-18-075-DC
MCTR17.45XU25.4A-25	17.45	25.4	452.2	56	490	TOHT08..	GP05-075, GP05-18-075-DC
MCTR17.50XM25A-25	17.5	25	452.2	56	490	TOHT08...	GP05-075, GP05-18-075-DC
MCTR18.00XM25A-25	18	25	477.2	56	517	TOHT08...	GP05-075, GP05-18-075-DC
MCTR18.24XU25.4-25	18.24	25.4	478	56	517	TOHT09..	GP06-085, GP06-20-085-DC
MCTR18.50XM25-25	18.5	25	478	56	517	TOHT09...	GP06-085, GP06-20-085-DC
MCTR18.64XU25.4-25	18.64	25.4	478	56	517	TOHT09..	GP06-085, GP06-20-085-DC
MCTR19.00XM25-25	19	25	503	56	543	TOHT09...	GP06-085, GP06-20-085-DC
MCTR19.05XU25.4-25	19.05	25.4	503	56	543	TOHT09..	GP06-085, GP06-20-085-DC
MCTR19.50XM25-25	19.5	25	503	56	543	TOHT09...	GP06-085, GP06-20-085-DC
MCTR19.94XU31.75-25	19.94	31.75	528	60	570	TOHT09..	GP06-085, GP06-20-085-DC
MCTR20.00XM32-25	20	32	528	60	570	TOHT09...	GP06-085, GP06-20-085-DC
MCTR20.62XU31.75-25	20.62	31.75	528.2	60	570	TOHT10..	GP06-085, GP06-20-085-DC
MCTR21.00XM32-25	21	32	553.2	60	596	TOHT10...	GP06-085, GP06-20-085-DC
MCTR22.00XM32-25	22	32	578.4	60	623	TOHT11...	GP06-100, GP06-20-100-DC
MCTR22.23XU31.75-25	22.23	31.75	578.4	60	623	TOHT11..	GP06-100, GP06-20-100-DC
MCTR23.00XM32-25	23	32	603.4	60	649	TOHT11...	GP06-100, GP06-20-100-DC
MCTR23.80XU31.75-25	23.8	31.75	628.4	60	676	TOHT11..	GP06-100, GP06-20-100-DC
MCTR24.00XM32-25	24	32	628.4	60	676	TOHT11...	GP06-100, GP06-20-100-DC
MCTR25.00XM32-25	25	32	653.4	60	702	TOHT11...	GP06-100, GP06-20-100-DC
MCTR25.40XU31.75-25	25.4	31.75	653.7	60	702	TOHT12..	GP06, GP06-20-120-DC
MCTR26.00XM40-25	26	40	678.7	70	729	TOHT12...	GP06, GP06-20-120-DC
MCTR26.97XU31.75X-25	26.97	31.75	703.7	60	755	TOHT12..	GP06, GP06-20-120-DC
MCTR27.00XM40-25	27	40	703.7	70	755	TOHT12...	GP06, GP06-20-120-DC
MCTR28.00XM40-25	28	40	703.7	70	757	TOHT12...	GP06, GP06-20-120-DC

DC	Tool diameter tolerance	Applicable tolerance range of hole diameter
12 - 28	0 / - 0.07	+ 0.05 / - 0.1

SPARE PARTS



Designation	Insert		Guide pad	
	Screw	Wrench	Screw	Wrench
MCTR12... - MCTR13.5...	SR10503833L040	T-7F	CSPB-2L043	IP-6F
MCTR14... - MCTR20.00...	SR14-560/S	T-8F	SR34-508	T-7F
MCTR20.62... - ...MCTR21...	SR34-506	T-9F	SR34-508	T-7F
MCTR22... - MCTR25.00...	SR14-571/S	T-10/5	SR34-508	T-7F
MCTR25.4... - MCTR28...	SR14-506	T-15F	SR34-508	T-7F

Recommended torque (N·m) for clamping: CSPB-2L043=0.7, SR34-506=0.9, SR34-508=0.9, SR14-560/S=1.2, SR10503833L040=1.3, SR14-571/S=3.2, SR14-506=4.8

MCTR-F L/D=25

Drill body for lathes and machining centers, L/D = 25, Tool diameter $\varnothing 28.58 - \varnothing 38.1$ mm

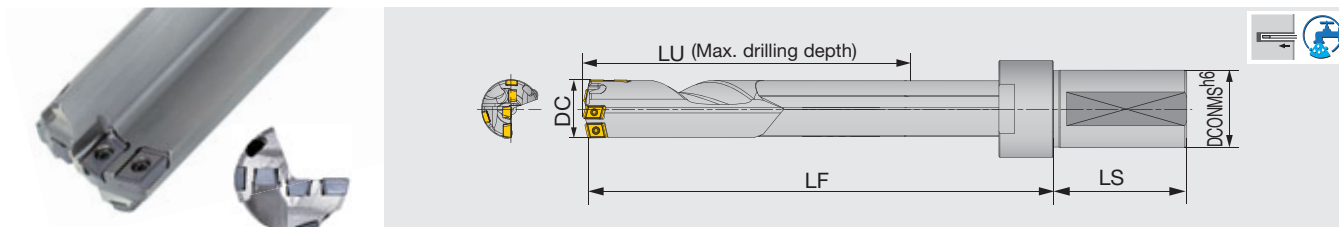

Designation	DC	DCONMS	LU	LS	LF	Insert	Guide pad
MCTR28.58XFU31.75-25	28.58	31.75	727.6	69	795	FBM06**-C, FBM055/060**-I, FBH06**-P	GP06, GP06-20-120-DC
MCTR30.00XFM40-25	30	40	777.9	69	848	FBM06**-C, FBM065/070**-I, FBH07**-P	GP06, GP06-20-120-DC
MCTR31.75XFU31.75-25	31.75	31.75	803	69	875	FBM06**-C, FBM065/070**-I, FBH07**-P	GP06, GP06-20-120-DC
MCTR34.93XFU31.75-25	34.93	31.75	878.1	69	953	FBM06**-C, FBM065/070**-I, FBH07**-P	GP07, GP07-20-120-DC
MCTR38.10XFU31.75-25	38.1	31.75	978.4	69	1059	FBM08**-C, FBM065/070**-I, FBH09**-P	GP08, GP08-25-155-DC

DC	Tool diameter tolerance	Applicable tolerance range of hole diameter
28.58 - 38.1	0 / - 0.07	+ 0.05 / - 0.1

Max. DC = 40: Specials available upon request

SPARE PARTS

Designation	Insert						Guide pad	
	Central		Intermediate		Peripheral		Screw	Wrench
	Screw	Wrench	Screw	Wrench	Screw	Wrench		
MCTR28...	CSTB-2.5	T-8F	CSTB-2.2	T-7F	CSTB-2.2	T-7F	SR34-508	T-7F
MCTR30... - MCTR31...	CSTB-2.5	T-8F	CSTB-2.5	T-8F	CSTB-2.5	T-8F	SR34-508	T-7F
MCTR34... - MCTR38...	CSTB-2.5	T-8F	CSTB-2.5	T-8F	CSTB-2.5	T-8F	CSTB-3S	T-9F

Recommended torque (N-m) for clamping: SR34-508=0.9, CSTB-2.2=1, CSTB-2.5=1.3, CSTB-3S=2.3

Note: The drill body surface is blackened for corrosion resistance and may appear uneven.

This, however, will not affect the performance of the drill.

MCTRCH L/D=25

Drill body for drilling cross hole applications on CNC lathes and machining centers, L/D = 25, Tool diameters $\varnothing 14$ mm - $\varnothing 28$ mm

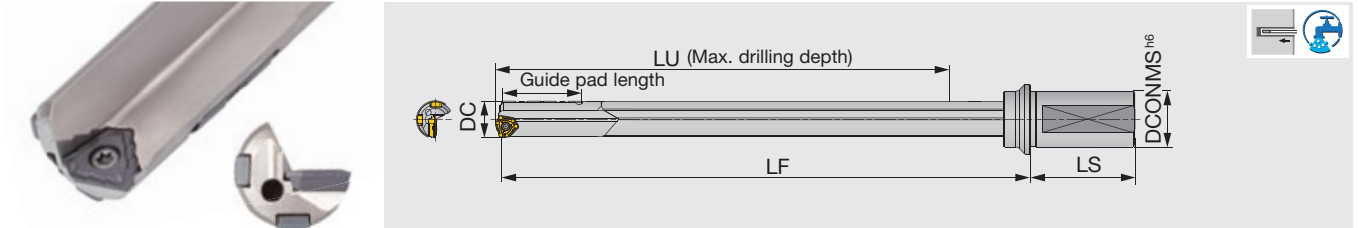

Designation	DC	DCONMS	LU	LS	LF	Insert	Guide pad	Guide pad length
MCTRCH14.00XM25-25	14	25	377	56	411	TOHT07...	GP05-060, GP05-18-060-DC	32
MCTRCH14.68XU25.4-25	14.68	25.4	377	56	412	TOHT07...	GP05-060, GP05-18-060-DC	32
MCTRCH15.00XM25-25	15	25	402	56	438	TOHT07...	GP05-060, GP05-18-060-DC	32
MCTRCH15.06XU25.4-25	15.06	25.4	402	56	438	TOHT07...	GP05-060, GP05-18-060-DC	32
MCTRCH16.00XM25A-25	16	25	427.2	56	464	TOHT08...	GP05-075, GP05-18-075-DC	32
MCTRCH18.00XM25A-25	18	25	477.2	56	517	TOHT08...	GP05-075, GP05-18-075-DC	32
MCTRCH18.24XU25.4-25	18.24	25.4	478	56	517	TOHT09...	GP06-085, GP06-20-085-DC	40
MCTRCH18.64XU25.4-25	18.64	25.4	478	56	517	TOHT09...	GP06-085, GP06-20-085-DC	40
MCTRCH19.00XM25-25	19	25	503	56	543	TOHT09...	GP06-085, GP06-20-085-DC	40
MCTRCH20.00XM32-25	20	32	528	60	570	TOHT09...	GP06-085, GP06-20-085-DC	40
MCTRCH23.00XM32-25	23	32	603.4	60	649	TOHT11...	GP06-100, GP06-20-100-DC	40
MCTRCH23.80XU31.75-25	23.8	31.75	628.4	60	676	TOHT11...	GP06-100, GP06-20-100-DC	40
MCTRCH24.00XM32-25	24	32	628.4	60	676	TOHT11...	GP06-100, GP06-20-100-DC	40
MCTRCH28.00XM40-25	28	40	703.7	70	757	TOHT12...	GP06, GP06-20-120-DC	40

DC	Tool diameter tolerance	Applicable tolerance range of hole diameter
14 - 28	0 / - 0.09	+ 0.05 / - 0.12

SPARE PARTS

Designation	Insert		Guide pad	
	Screw	Wrench	Screw	Wrench
MCTRCH14... - MCTRCH20...	SR14-560/S	T-8F	SR34-508	T-7F
MCTRCH23... - MCTRCH24...	SR14-571/S	T-10/5	SR34-508	T-7F
MCTRCH28...	SR14-506	T-15F	SR34-508	T-7F

Recommended torque (N·m) for clamping: SR34-508=0.9, SR14-560/S=1.2, SR14-571/S=3.2, SR14-506=4.8

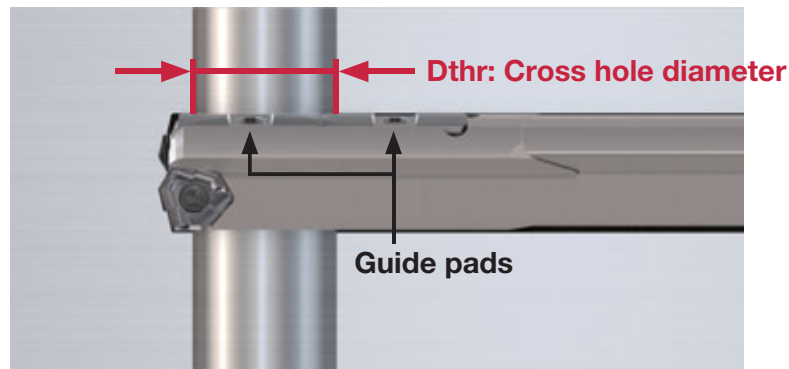

Reference pages: Inserts → [P.23](#), Guide pads → [P.25](#)

DESIGNATION FOR TAILOR-MADE TOOLS

Special tool code may be created per below according to your specific drilling needs.

1 **MCTR** **2** **18.50** **XM** **3** **25** - **4** **22**

1 Series		2 Drill dia. DC (mm)		3 Driver dia. DCONMS (mm)		4 LU/DC ratio	
MCTR	DeepTri-Drill (For machining centers and lathes)	18.50	18.50	25	25		
MCTRCH	DeepTri-Drill (For cross hole drilling on machining centers and CNC lathes)						

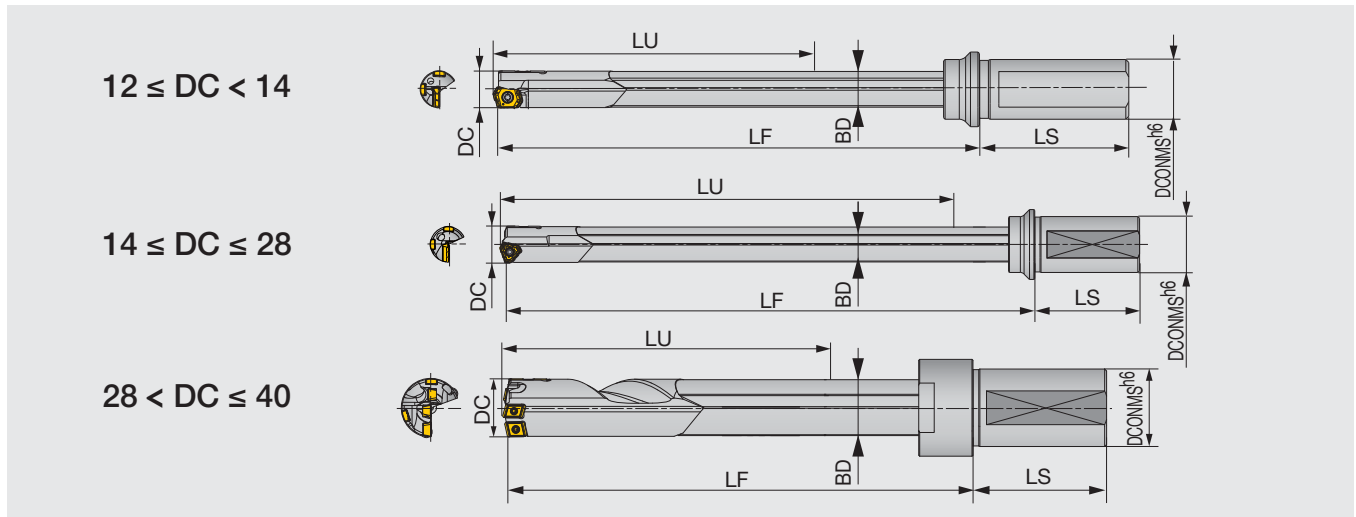

AVAILABLE RANGE OF TAILOR-MADE DRILL BODIES

DC	DCONMS	LU	LS	LF	BD	DC	DCONMS	LU	LS	LF	BD
12 - 12.49	20	124.8 - 326.8	50	153 - 225	11.5	24.7 - 25.69	32	211.4 - 653.7	60	260 - 702	24
12.5 - 12.99	20	123.8 - 326.8	50	153 - 226	12	25.7 - 26.69	40	219.7 - 678.7	70	270 - 719	25
13 - 13.49	25	122.8 - 351.8	56	156 - 245	12.5	26.7 - 27.69	40	227.7 - 703.7	70	279 - 745	26
13.5 - 13.99	25	122.8 - 351.8	56	156 - 245	13	27.7 - 28	40	227.7 - 703.7	70	281 - 747	27
14 - 14.49	25	122 - 377	56	156 - 411	13.5	28.01 - 29	40	148.7 - 728.7	69	215 - 795	27
14.5 - 14.99	25	122 - 377	56	157 - 412	14	29.01 - 29.99	40	153.7 - 753.7	69	222 - 822	28
15 - 15.99	25	130 - 402	56	166 - 438	14.5	30 - 31	40	158.7 - 778.7	69	228 - 848	29
16 - 16.79	25	138.2 - 427.2	56	175 - 464	15.5	31.01 - 32	40	163.7 - 803.7	69	235 - 875	30
16.8 - 17.69	25	146.2 - 452.2	56	184 - 490	16.2	32.01 - 33	40	168.7 - 828.7	69	241 - 901	31
17.7 - 18.69	25	154.2 - 478	56	194 - 517	17.2	33.01 - 34	40	173.7 - 853.7	69	248 - 928	32
18.7 - 19.69	25	163 - 503	56	203 - 543	18.2	34.01 - 35	40	178.7 - 878.7	69	253 - 953	32
19.7 - 20.69	32	171 - 528.2	60	213 - 570	19	35.01 - 36	40	183.7 - 903.7	69	261 - 981	34
20.7 - 21.69	32	179.2 - 553.2	60	222 - 596	20	36.01 - 37	40	188.7 - 928.7	69	266 - 1006	34
21.7 - 22.69	32	187.2 - 578.4	60	232 - 623	21	37.01 - 38	40	193.7 - 953.7	69	274 - 1034	36
22.7 - 23.69	32	195.4 - 603.4	60	241 - 649	22	38.01 - 39	40	198.7 - 978.7	69	279 - 1059	36
23.7 - 24.69	32	203.4 - 628.4	60	251 - 676	23	39.01 - 40	40	203.7 - 1003.7	69	287 - 1087	38

TRLG

Drill body for gundrill machines, Tool diameters $\phi 12 - \phi 28$ mm

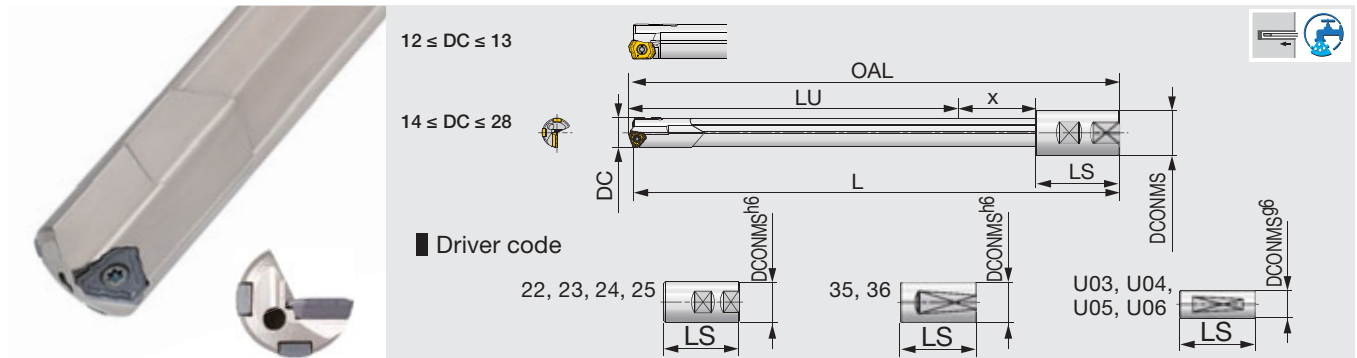

Designation	DC	L	DCONMS	LU	OAL	LS	x	Driver code	Insert	Guide pad
TRLG12.00X800-U03	12	800	19.05	713.8	801.8	70	18	U03	LOGT06...	GP04-055, GP04-16-055-DC
TRLG12.00X800-22	12	800	20	733.8	801.8	50	18	22	LOGT06...	GP04-055, GP04-16-055-DC
TRLG12.00X1000-U03	12	1000	19.05	913.8	1001.8	70	18	U03	LOGT06...	GP04-055, GP04-16-055-DC
TRLG12.00X1000-22	12	1000	20	933.8	1001.8	50	18	22	LOGT06...	GP04-055, GP04-16-055-DC
TRLG12.00X1650-U03	12	1650	19.05	1563.8	1651.8	70	18	U03	LOGT06...	GP04-055, GP04-16-055-DC
TRLG12.00X1650-22	12	1650	20	1583.8	1651.8	50	18	22	LOGT06...	GP04-055, GP04-16-055-DC
TRLG12.70X1219-U04	12.7	1219	25.4	1131.8	1220.8	70	19	U04	LOGT06...	GP04-055, GP04-16-055-DC
TRLG12.70X1524-U04	12.7	1524	25.4	1436.8	1525.8	70	19	U04	LOGT06...	GP04-055, GP04-16-055-DC
TRLG13.00X800-U04	13	800	25.4	711.8	801.8	70	20	U04	LOGT06...	GP04-055, GP04-16-055-DC
TRLG13.00X800-23	13	800	25	725.8	801.8	56	20	23	LOGT06...	GP04-055, GP04-16-055-DC
TRLG13.00X1000-U04	13	1000	25.4	911.8	1001.8	70	20	U04	LOGT06...	GP04-055, GP04-16-055-DC
TRLG13.00X1000-23	13	1000	25	925.8	1001.8	56	20	23	LOGT06...	GP04-055, GP04-16-055-DC
TRLG13.00X1650-U04	13	1650	25.4	1561.8	1651.8	70	20	U04	LOGT06...	GP04-055, GP04-16-055-DC
TRLG13.00X1650-23	13	1650	25	1575.8	1651.8	56	20	23	LOGT06...	GP04-055, GP04-16-055-DC
TRLG13.49X1219-U04	13.49	1219	25.4	1130.8	1220.8	70	20	U04	LOGT06...	GP04-055, GP04-16-055-DC
TRLG13.49X1527-U04	13.49	1527	25.4	1438.8	1528.8	70	20	U04	LOGT06...	GP04-055, GP04-16-055-DC
TRLG14.00X800-23	14	800	25	725	802	56	21	23	TOHT07...	GP05-060, GP05-18-060-DC
TRLG14.00X800-U04	14	800	25.4	711	802	70	21	U04	TOHT07...	GP05-060, GP05-18-060-DC
TRLG14.00X1000-23	14	1000	25	925	1002	56	21	23	TOHT07...	GP05-060, GP05-18-060-DC
TRLG14.00X1000-U04	14	1000	25.4	911	1002	70	21	U04	TOHT07...	GP05-060, GP05-18-060-DC
TRLG14.00X1650-23	14	1650	25	1575	1652	56	21	23	TOHT07...	GP05-060, GP05-18-060-DC
TRLG14.00X1650-U04	14	1650	25.4	1561	1652	70	21	U04	TOHT07...	GP05-060, GP05-18-060-DC
TRLG14.50X800-23	14.5	800	25	724	802	56	22	23	TOHT07...	GP05-060, GP05-18-060-DC
TRLG14.50X800-U04	14.5	800	25.4	710	802	70	22	U04	TOHT07...	GP05-060, GP05-18-060-DC
TRLG14.50X1000-23	14.5	1000	25	924	1002	56	22	23	TOHT07...	GP05-060, GP05-18-060-DC
TRLG14.50X1000-U04	14.5	1000	25.4	910	1002	70	22	U04	TOHT07...	GP05-060, GP05-18-060-DC
TRLG14.50X1650-23	14.5	1650	25	1574	1652	56	22	23	TOHT07...	GP05-060, GP05-18-060-DC
TRLG14.50X1650-U04	14.5	1650	25.4	1560	1652	70	22	U04	TOHT07...	GP05-060, GP05-18-060-DC
TRLG15.00X800-23	15	800	25	723	802	56	23	23	TOHT07...	GP05-060, GP05-18-060-DC
TRLG15.00X800-U04	15	800	25.4	709	802	70	23	U04	TOHT07...	GP05-060, GP05-18-060-DC
TRLG15.00X1000-23	15	1000	25	923	1002	56	23	23	TOHT07...	GP05-060, GP05-18-060-DC
TRLG15.00X1000-U04	15	1000	25.4	909	1002	70	23	U04	TOHT07...	GP05-060, GP05-18-060-DC
TRLG15.00X1650-23	15	1650	25	1573	1652	56	23	23	TOHT07...	GP05-060, GP05-18-060-DC
TRLG15.00X1650-U04	15	1650	25.4	1559	1652	70	23	U04	TOHT07...	GP05-060, GP05-18-060-DC
TRLG16.00X800-23A	16	800	25	722.2	802.2	56	24	23	TOHT08...	GP05-075, GP05-18-075-DC
TRLG16.00X800-U04A	16	800	25.4	708.2	802.2	70	24	U04	TOHT08...	GP05-075, GP05-18-075-DC
TRLG16.00X1000-23A	16	1000	25	922.2	1002.2	56	24	23	TOHT08...	GP05-075, GP05-18-075-DC
TRLG16.00X1000-U04A	16	1000	25.4	908.2	1002.2	70	24	U04	TOHT08...	GP05-075, GP05-18-075-DC
TRLG16.00X1500-23A	16	1500	25	1422.2	1502.2	56	24	23	TOHT08...	GP05-075, GP05-18-075-DC
TRLG16.00X1500-U04A	16	1500	25.4	1408.2	1502.2	70	24	U04	TOHT08...	GP05-075, GP05-18-075-DC

Designation	DC	L	DCONMS	LU	OAL	LS	x	Driver code	Insert	Guide pad
TRLG17.00X800-23A	17	800	25	721.2	802.2	56	25	23	TOHT08...	GP05-075, GP05-18-075-DC
TRLG17.00X800-U04A	17	800	25.4	707.2	802.2	70	25	U04	TOHT08...	GP05-075, GP05-18-075-DC
TRLG17.00X1000-23A	17	1000	25	921.2	1002.2	56	25	23	TOHT08...	GP05-075, GP05-18-075-DC
TRLG17.00X1000-U04A	17	1000	25.4	907.2	1002.2	70	25	U04	TOHT08...	GP05-075, GP05-18-075-DC
TRLG18.00X800-23A	18	800	25	719.2	802.2	56	27	23	TOHT08...	GP05-075, GP05-18-075-DC
TRLG18.00X800-U04A	18	800	25.4	705.2	802.2	70	27	U04	TOHT08...	GP05-075, GP05-18-075-DC
TRLG18.00X1000-23A	18	1000	25	919.2	1002.2	56	27	23	TOHT08...	GP05-075, GP05-18-075-DC
TRLG18.00X1000-U04A	18	1000	25.4	905.2	1002.2	70	27	U04	TOHT08...	GP05-075, GP05-18-075-DC
TRLG18.00X1500-23A	18	1500	25	1419.2	1502.2	56	27	23	TOHT08...	GP05-075, GP05-18-075-DC
TRLG18.00X1500-U04A	18	1500	25.4	1405.2	1502.2	70	27	U04	TOHT08...	GP05-075, GP05-18-075-DC
TRLG18.50X1500-23	18.5	1500	25	1420	1503	56	27	23	TOHT09...	GP06-085, GP06-20-085-DC
TRLG18.50X1500-U04	18.5	1500	25.4	1406	1503	70	27	U04	TOHT09...	GP06-085, GP06-20-085-DC
TRLG19.00X800-23	19	800	25	719	803	56	28	23	TOHT09...	GP06-085, GP06-20-085-DC
TRLG19.00X800-U04	19	800	25.4	705	803	70	28	U04	TOHT09...	GP06-085, GP06-20-085-DC
TRLG19.00X1000-23	19	1000	25	919	1003	56	28	23	TOHT09...	GP06-085, GP06-20-085-DC
TRLG19.00X1000-U04	19	1000	25.4	905	1003	70	28	U04	TOHT09...	GP06-085, GP06-20-085-DC
TRLG20.00X800-24	20	800	32	713	803	60	30	24	TOHT09...	GP06-085, GP06-20-085-DC
TRLG20.00X800-U05	20	800	31.75	703	803	70	30	U05	TOHT09...	GP06-085, GP06-20-085-DC
TRLG20.00X1000-24	20	1000	32	913	1003	60	30	24	TOHT09...	GP06-085, GP06-20-085-DC
TRLG20.00X1000-U05	20	1000	31.75	903	1003	70	30	U05	TOHT09...	GP06-085, GP06-20-085-DC
TRLG21.00X1000-24	21	1000	32	912.2	1003.2	60	31	24	TOHT10...	GP06-085, GP06-20-085-DC
TRLG21.00X1000-U05	21	1000	31.75	902.2	1003.2	70	31	U05	TOHT10...	GP06-085, GP06-20-085-DC
TRLG22.00X1000-24	22	1000	32	910.4	1003.4	60	33	24	TOHT11...	GP06-100, GP06-20-100-DC
TRLG22.00X1000-U05	22	1000	31.75	900.4	1003.4	70	33	U05	TOHT11...	GP06-100, GP06-20-100-DC
TRLG22.00X1500-24	22	1500	32	1410.4	1503.4	60	33	24	TOHT11...	GP06-100, GP06-20-100-DC
TRLG22.00X1500-U05	22	1500	31.75	1400.4	1503.4	70	33	U05	TOHT11...	GP06-100, GP06-20-100-DC
TRLG23.00X1000-24	23	1000	32	909.4	1003.4	60	34	24	TOHT11...	GP06-100, GP06-20-100-DC
TRLG23.00X1000-U05	23	1000	31.75	899.4	1003.4	70	34	U05	TOHT11...	GP06-100, GP06-20-100-DC
TRLG23.00X1500-24	23	1500	32	1409.4	1503.4	60	34	24	TOHT11...	GP06-100, GP06-20-100-DC
TRLG23.00X1500-U05	23	1500	31.75	1399.4	1503.4	70	34	U05	TOHT11...	GP06-100, GP06-20-100-DC
TRLG24.00X1000-24	24	1000	32	907.4	1003.4	60	36	24	TOHT11...	GP06-100, GP06-20-100-DC
TRLG24.00X1000-U05	24	1000	31.75	897.4	1003.4	70	36	U05	TOHT11...	GP06-100, GP06-20-100-DC
TRLG24.00X1500-24	24	1500	32	1407.4	1503.4	60	36	24	TOHT11...	GP06-100, GP06-20-100-DC
TRLG24.00X1500-U05	24	1500	31.75	1397.4	1503.4	70	36	U05	TOHT11...	GP06-100, GP06-20-100-DC
TRLG25.00X1000-24	25	1000	32	906.4	1003.4	60	37	24	TOHT11...	GP06-100, GP06-20-100-DC
TRLG25.00X1000-U05	25	1000	31.75	896.4	1003.4	70	37	U05	TOHT11...	GP06-100, GP06-20-100-DC
TRLG26.00X1000-25	26	1000	40	894.7	1003.7	70	39	25	TOHT12...	GP06, GP06-20-120-DC
TRLG26.00X1000-U06	26	1000	38.1	894.7	1003.7	70	39	U06	TOHT12...	GP06, GP06-20-120-DC
TRLG27.00X1000-25	27	1000	40	893.7	1003.7	70	40	25	TOHT12...	GP06, GP06-20-120-DC
TRLG27.00X1000-U06	27	1000	38.1	893.7	1003.7	70	40	U06	TOHT12...	GP06, GP06-20-120-DC
TRLG28.00X1000-25	28	1000	40	891.7	1003.7	70	42	25	TOHT12...	GP06, GP06-20-120-DC
TRLG28.00X1000-U06	28	1000	38.1	891.7	1003.7	70	42	U06	TOHT12...	GP06, GP06-20-120-DC

DC	Tool diameter tolerance	Applicable tolerance range of hole diameter
12 - 28	0 / - 0.07	+ 0.05 / - 0.1

SPARE PARTS

Designation	Insert		Guide pad	
	Screw	Wrench	Screw	Wrench
TRLG12... - TRLG13...	SR10503833L040	T-7F	CSPB-2L043	IP-6F
TRLG14... - TRLG20...	SR14-560/S	T-8F	SR34-508	T-7F
TRLG21...	SR34-506	T-9F	SR34-508	T-7F
TRLG22... - TRLG25...	SR14-571/S	T-10/5	SR34-508	T-7F
TRLG26... - TRLG28...	SR14-506	T-15F	SR34-508	T-7F

Recommended torque (N·m) for clamping: CSPB-2L043=0.7, SR34-508=0.9, SR34-506=0.9, SR14-560/S=1.2, SR10503833L040=1.3, SR14-571/S=3.2, SR14-506=4.8

Reference pages: Inserts → **P.23**, Guide pads → **P.25**

TRLGCH

Drill body for drilling cross hole applications on gun drilling machines, Tool diameters $\phi 14.68$ mm - $\phi 24$ mm

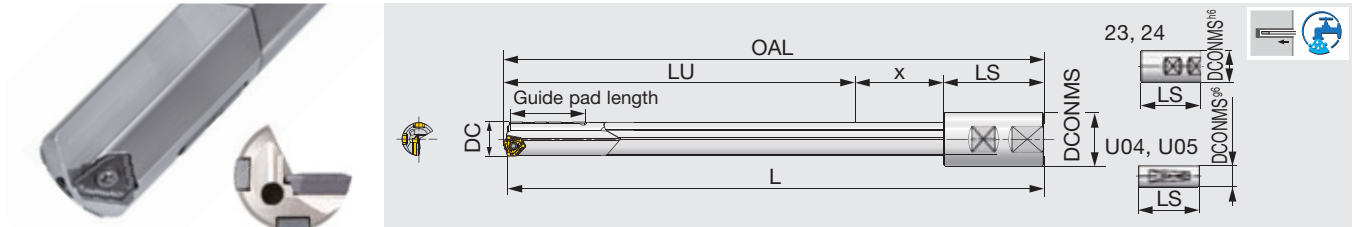

Designation	DC	L	DCONMS	LU	OAL	LS	X	Driver code	Insert	Guide pad	Guide pad length
TRLGCH14.68X1830-U05	14.68	1830	31.75	1740	1832	70	22	U05	TOHT07...	GP05-060, GP05-18-060-DC	32
TRLGCH15.00X1650-U04	15	1650	25.4	1559	1652	70	23	U04	TOHT07...	GP05-060, GP05-18-060-DC	32
TRLGCH15.00X1650-23	15	1650	25	1573	1652	56	23	23	TOHT07...	GP05-060, GP05-18-060-DC	32
TRLGCH15.06X1830-U05	15.06	1830	31.75	1739	1832	70	23	U05	TOHT07...	GP05-060, GP05-18-060-DC	32
TRLGCH18.00X1650-U04A	18	1650	25.4	1555.2	1652.2	70	27	U04	TOHT08...	GP05-075, GP05-18-075-DC	32
TRLGCH18.00X1650-23A	18	1650	25	1569.2	1652.2	56	27	23	TOHT08...	GP05-075, GP05-18-075-DC	40
TRLGCH18.24X1830-U05	18.24	1830	31.75	1736	1833	70	27	U05	TOHT09...	GP06-085, GP06-20-085-DC	40
TRLGCH18.64X1830-U05	18.64	1830	31.75	1736	1833	70	27	U05	TOHT09...	GP06-085, GP06-20-085-DC	40
TRLGCH23.00X1650-U05	23	1650	31.75	1549.4	1653.4	70	34	U05	TOHT11...	GP06-100, GP06-20-100-DC	40
TRLGCH23.00X1650-24	23	1650	32	1559.4	1653.4	60	34	24	TOHT11...	GP06-100, GP06-20-100-DC	40
TRLGCH23.42X1830-U05	23.42	1830	31.75	1729.4	1833.4	70	34	U05	TOHT11...	GP06-100, GP06-20-100-DC	40
TRLGCH23.80X1830-U05	23.8	1830	31.75	1727.4	1833.4	70	36	U05	TOHT11...	GP06-100, GP06-20-100-DC	40
TRLGCH24.00X1650-U05	24	1650	31.75	1547.4	1653.4	70	36	U05	TOHT11...	GP06-100, GP06-20-100-DC	40
TRLGCH24.00X1650-24	24	1650	32	1557.4	1653.4	60	36	24	TOHT11...	GP06-100, GP06-20-100-DC	40

DC	Tool diameter tolerance	Applicable tolerance range of hole diameter
14.68 - 24	0 / - 0.09	+ 0.05 / - 0.12

SPARE PARTS

Designation	Insert		Guide pad	
	Screw	Wrench	Screw	Wrench
TRLGCH14... - TRLGCH18...	SR14-560/S	T-8F	SR34-508	T-7F
TRLGCH23... - TRLGCH24...	SR14-571/S	T-10/5	SR34-508	T-7F

Recommended torque (N·m) for clamping: SR34-508=0.9, R14-560/S=1.2, SR14-571/S=3.2

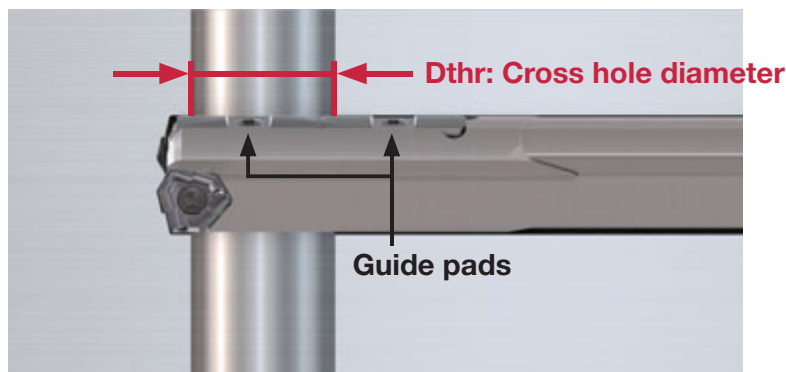

Reference pages: Inserts → **P.23**, Guide pads → **P.25**

TRLG

Drill body for gundrill machines, Tool diameter $\phi 29.36$, $\phi 30$ mm

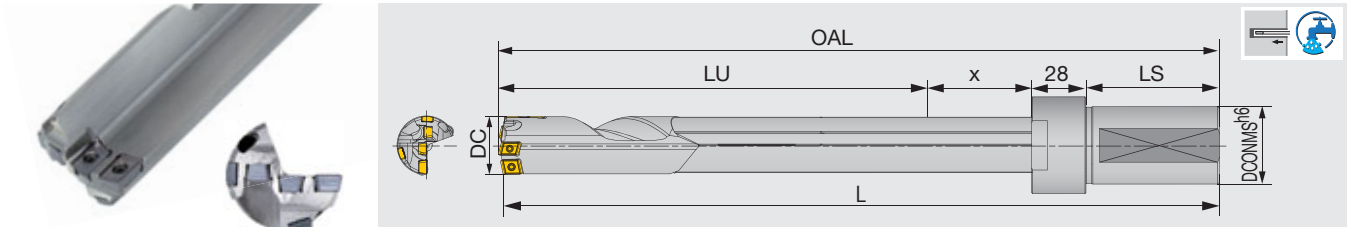

Designation	DC	L	DCONMS	LU	OAL	LS	x	Driver code	Insert	Guide pad
TRLG29.36X1828-FU31.75	29.36	1828	31.75	1689.6	1830.6	69	44	FU31.75	FBM06**-C, FBM055/060**-I, FBH06**-P	GP06, GP06-20-120-DC
TRLG30.00X1000-FM40	30	1000	40	860.9	1002.9	69	45	FM40	FBM06**-C, FBM065/070**-I, FBH07**-P	GP06, GP06-20-120-DC
TRLG30.00X1650-FM40	30	1650	40	1510.9	1652.9	69	45	FM40	FBM06**-C, FBM065/070**-I, FBH07**-P	GP06, GP06-20-120-DC
TRLG30.00X1650-FU38.1	30	1650	38.1	1510.9	1652.9	69	45	FU38.1	FBM06**-C, FBM065/070**-I, FBH07**-P	GP06, GP06-20-120-DC

DC	Tool diameter tolerance	Applicable tolerance range of hole diameter
29.36, 30	0 / - 0.07	+ 0.05 / - 0.1

Max. DC = 40: Available tailor-made tools

Designation	Insert						Guide pad	
	Central		Intermediate		Peripheral		Screw	Wrench
	Screw	Wrench	Screw	Wrench	Screw	Wrench		
TRLG29.36...	CSTB-2.5	T-8F	CSTB-2.2	T-7F	CSTB-2.2	T-7 F	SR34-508	T-7F
TRLG30...	CSTB-2.5	T-8F	CSTB-2.5	T-8F	CSTB-2.5	T-8F	SR34-508	T-7F

Recommended torque (N·m) for clamping: SR34-508=0.9, CSTB-2.5=1.3

Note: The drill body surface is blackened for corrosion resistance and may appear uneven. This, however, will not affect the performance of the drill.

Reference pages: Inserts → [P.24](#), Guide pads → [P.25](#)

DESIGNATION FOR TAILOR-MADE TOOLS

For tailor-made drills, use the guide below to make the designation (Cat. No).

1 **TRLG** **2** **18.50** **X** **3** **900** **-** **4** **23**

1 Series		2 Drill dia. DC (mm)		3 Overall length: L (mm)		4 Driver code	
TRLG	DeepTri-Drill (For gundrill machines)	18.50	18.50	900	900	23	23
TRLGCH	DeepTri-Drill (For cross hole drilling on gundrilling machines)						

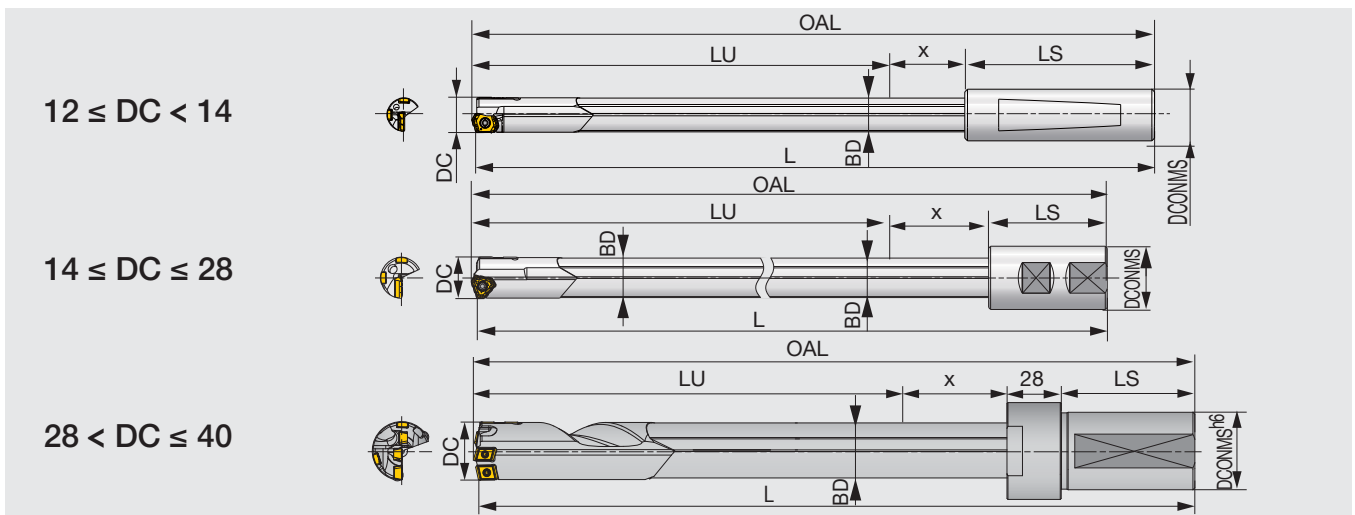

AVAILABLE RANGE OF TAILOR-MADE DRILL BODIES

DC	L	x	BD	DC	L	x	BD
12 - 12.49	400 - 2400	18	11.5	24.7 - 25.69	400 - 2400	37	24
12.5 - 12.99	400 - 2400	19	12	25.7 - 26.69	400 - 2400	39	25
13 - 13.49	400 - 2400	20	12.5	26.7 - 27.69	400 - 2400	40	26
13.5 - 13.99	400 - 2400	20	13	27.7 - 28	400 - 2400	42	27
14 - 14.49	400 - 2400	21	13.5	28.01 - 29	400 - 2400	42	27
14.5 - 14.99	400 - 2400	22	14	29.01 - 29.99	400 - 2400	44	28
15 - 15.99	400 - 2400	23	14.5	30 - 31	400 - 2400	45	29
16 - 16.79	400 - 2400	24	15.5	31.01 - 32	400 - 2400	47	30
16.8 - 17.69	400 - 2400	25	16.2	32.01 - 33	400 - 2400	48	31
17.7 - 18.69	400 - 2400	27	17.2	33.01 - 34	400 - 2400	50	32
18.7 - 19.69	400 - 2400	28	18.2	34.01 - 35	400 - 2400	50	32
19.7 - 20.69	400 - 2400	30	19	35.01 - 36	400 - 2400	53	34
20.7 - 21.69	400 - 2400	31	20	36.01 - 37	400 - 2400	53	34
21.7 - 22.69	400 - 2400	33	21	37.01 - 38	400 - 2400	56	36
22.7 - 23.69	400 - 2400	34	22	38.01 - 39	400 - 2400	56	36
23.7 - 24.69	400 - 2400	36	23	39.01 - 40	400 - 2400	59	38

Please provide the driver shape necessary for your request

INSERTS

LOGT-NDJ

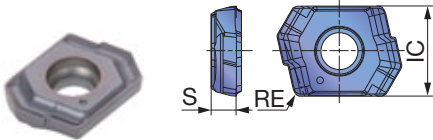

Designation	DCN-DCX	AH725	IC	S	RE
LOGT060204R-NDJ	12 - 13.99	●	7.08	2	0.4

TOHT-NDL (07..., 08...)

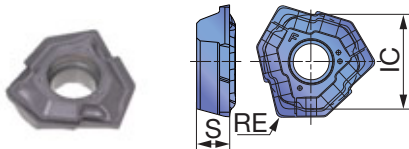

Designation	DCN-DCX	AH725	IC	S	RE
TOHT070304R-NDL	14 - 15.99	●	7.69	2.3	0.4
TOHT080305R-NDL	16 - 18	●	8.55	2.8	0.5
TOHT090305R-NDL	18.01 - 20	●	8.32	3	0.5
TOHT100305R-NDL	20.01 - 21.99	●	9.23	3.3	0.5
TOHT110405R-NDL	22 - 25	●	10.4	3.8	0.5
TOHT120405R-NDL	25.01 - 28	●	11.59	4.3	0.5

TOHT-NDL (09... - 12...)

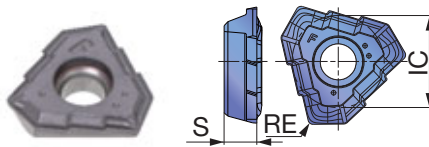

TOHT-NDJ (07..., 08...)

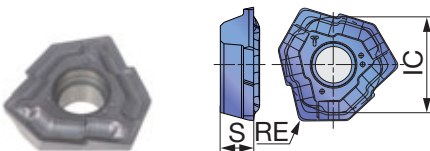

Designation	DCN-DCX	AH725	IC	S	RE
TOHT070304R-NDJ	14 - 15.99	●	7.69	2.3	0.4
TOHT080305R-NDJ	16 - 18	●	8.55	2.8	0.5
TOHT090305R-NDJ	18.01 - 20	●	8.32	3	0.5
TOHT100305R-NDJ	20.01 - 21.99	●	9.23	3.3	0.5
TOHT110405R-NDJ	22 - 25	●	10.4	3.8	0.5
TOHT120405R-NDJ	25.01 - 28	●	11.59	4.3	0.5

TOHT-NDJ (09... - 12...)

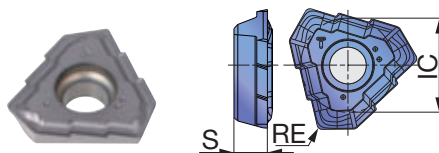

■ Identifications for NDL and NDJ geometries ■ Recommended feed rates

Chipbreaker	NDL	NDJ
Cutting edge strength	Strong	Very strong
ID on insert		

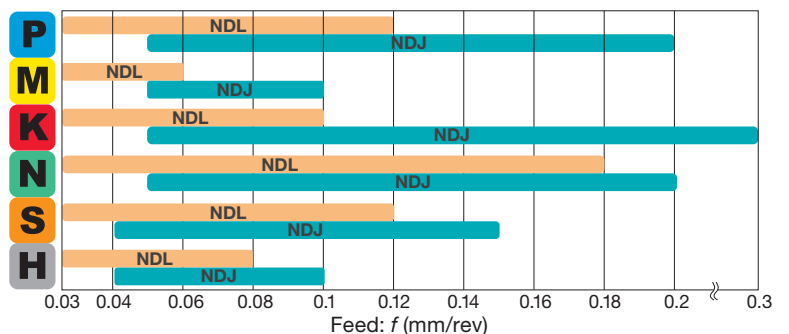

FBM-C (Central inserts)

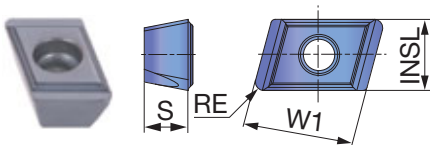

Designation	DCN-DCX	UC2220	UC3120	INSL	W1	S	RE
FBM06504LG-C	28.01 - 35	●		6.5	10	4	0.8
FBM08004LG-C	35.01 - 40	●		8	10	4	0.8

FBM-I (Intermediate inserts)

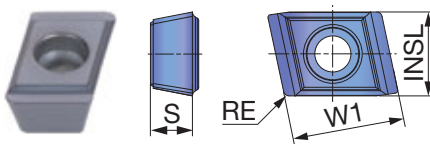

Designation	DCN-DCX	UC2220	UC3120	AH725	INSL	W1	S	RE	Chipbreaker Type	
									G type chipbreaker	DL type chipbreaker
FBM05503RG-I	28.01 - 29.99	●			5.5	8	3	0.4	FBM05503RG-I	FBM060304R-DL-I
New FBM060304R-DL-I	28.01 - 29.99			●	5.5	8	3	0.4	FBM06504RG-I	FBM070404R-DL-I
FBM06504RG-I	30 - 40	●			6.5	10	4	0.4		
New FBM070404R-DL-I	30 - 40			●	6.5	10	4	0.4		

The designation of insert with G type and DL type is different, even in the same shape. Please refer to the table on the above to check the insert designation. Both inserts can be mounted on the drill head.

Recommended feed rates

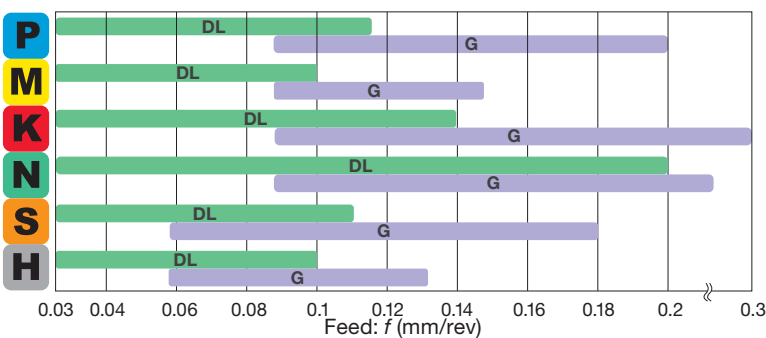

For cross hole drilling, please use the new DL type chipbreaker because the feed needs to be reduced.

FBH-P (Peripheral inserts)

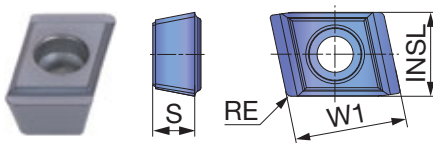

Designation	DCN-DCX	UC2220	UC3120	INSL	W1	S	RE
FBH06003RG-P	28.01 - 29.99	●	●	6	8	3	0.4
FBH07504RG-P	30 - 38	●	●	7.5	10	4	0.4
FBH09004RG-P	38.01 - 40	●	●	9	10	4	0.4

● : Line - up
Package quantity = 10 pcs.

CARBIDE GUIDE PADS

GP04,05, 06, 07, 08

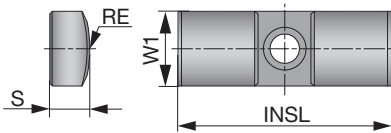

Designation	DC	F1122	F2122	New FH3135	W1	INSL	S	RE	Chamfer
GP04-055	12 - 13.99	●	●		4	16	2	5.5	Single
GP04-16-055-DC	12 - 13.99			●	4	16	2	5.5	Double
GP05-060	14 - 15.99	●	●		5	18	2.5	6	Single
GP05-18-060-DC	14 - 15.99			●	5	18	2.5	6	Double
GP05-075	16 - 18	●	●		5	18	2.5	7.5	Single
GP05-18-075-DC	16 - 18			●	5	18	2.5	7.5	Double
GP06-085	18.01 - 21	●	●		6	20	3	8.5	Single
GP06-20-085-DC	18.01 - 21			●	6	20	3	8.5	Double
GP06-100	21.01 - 25	●	●		6	20	3	10	Single
GP06-20-100-DC	21.01 - 25			●	6	20	3	10	Double
GP06	25.01 - 33	●	●		6	20	3	12	Single
GP06-20-120-DC	25.01 - 33			●	6	20	3	12	Double
GP07	33.01 - 38	●	●		7	20	3.5	12	Single
GP07-20-120-DC	33.01 - 38			●	7	20	3.5	12	Double
GP08	38.01 - 40	●	●		8	25	4.5	15.5	Single
GP08-25-155-DC	38.01 - 40			●	8	25	4.5	15.5	Double

● : Standard
Package quantity = 5 pcs.

Guide pad grade and the timing for replacement

Guide pads are subject to wear, like inserts

- The guide pad has two sides.
- Each guide pad can be used on two sides. When the first corner wears out to 70% of the width, reverse the guide pad to use the second side.
- Replace with a new guide pad when the second side wears out.

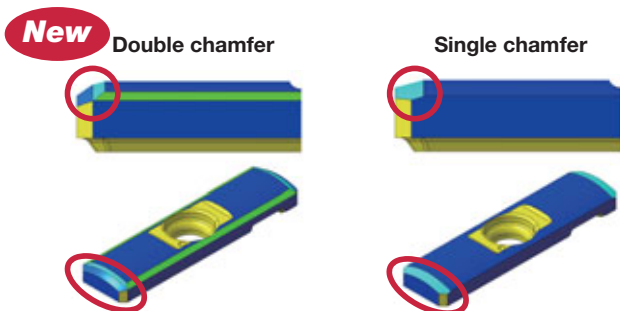
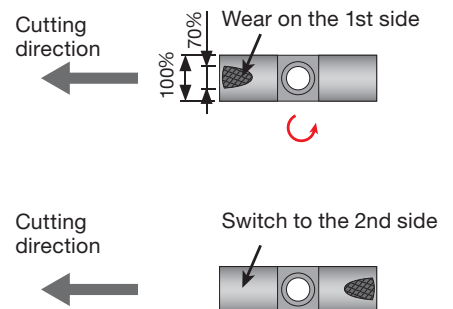
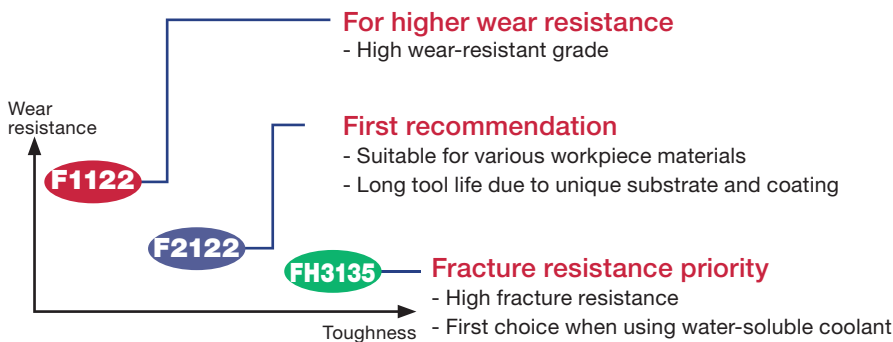

SHIMS

For fine adjustments of hole diameters

SHIMSET-GP04

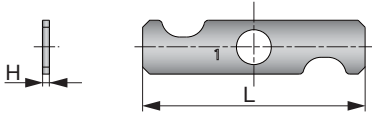

SHIMSET-GP05

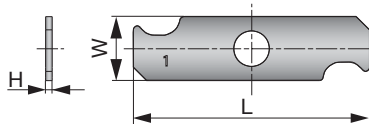

SHIMSET-GP06

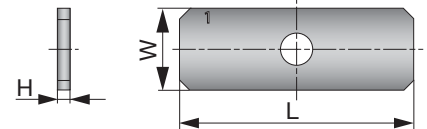

Designation	DC	W	L	H
SHIMSET-GP04	12 - 13.99	4	16	0.01 - 0.05
SHIMSET-GP05	14 - 18	5	18	0.01 - 0.05
SHIMSET-GP06	18.01 - 33	5	18	0.01 - 0.05

- A shim set contains 5 shims in thicknesses of 0.01 mm, 0.02 mm, 0.03 mm, 0.04 mm, and 0.05 mm, respectively.
 - Adjusting shims are sold by set only, not to be sold separately.

Shim combinations for various diameters

Diameter adjustments	Shim(s) for measuring guide pad	Shim(s) for supporting guide pad	Number of shim sets needed
+0.01	0.01	-	1
+0.02	0.02	0.01	1
+0.03	0.03	0.01 + 0.02	1
+0.04	0.04	0.01 + 0.03	1
+0.05	0.05	0.02 + 0.03	1
+0.06	0.01 + 0.05	0.02 + 0.04	1
+0.07	0.02 + 0.05	0.03 + 0.04	1
+0.08	0.03 + 0.05	0.04 + 0.04	2
+0.09	0.04 + 0.05	0.04 + 0.05	2
+0.1	0.05 + 0.05	0.04 + 0.04 + 0.02	2

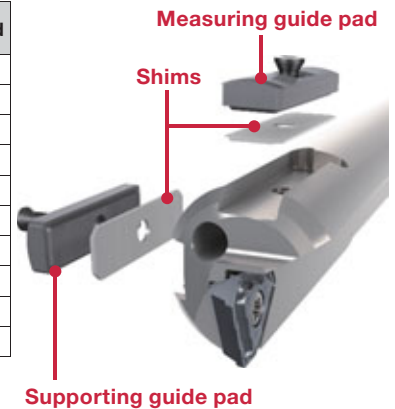

How to install adjusting shims

1. Measure the drill diameter.

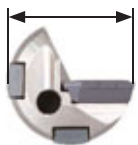

3. Remove the guide pads.



2. Select the shim sizes for adjustment.

Note: Consider that the hole diameter may expand during drilling (for +0.02 to +0.03 mm).

<https://www.tungaloy.com/product/deeptri-drill/>



4. Place the shims underneath both guide pads.

5. Measure to make sure the required diameter is achieved.



6. Drill a test hole to ensure the required hole size is achieved.

Note: For higher drilling precision, drill a hole after Step 1 to confirm the size difference between the measured drill diameter and actual drilled hole diameter.

STANDARD CUTTING CONDITIONS

ISO	Workpiece material	Priority	Chip-breaker	Cutting speed Vc (m/min)	Feed: f (mm/rev)			
					ø12 - ø13.99	ø14 - ø18	ø18.01 - ø28	ø28.01 - ø40
P	Low carbon steel (C < 0.3) SS400 / St42-1, SM490 / St52-3, S25C / C25, etc.	For low feed machines	NDL	50 - 100	-	0.03 - 0.1	0.03 - 0.1	-
		First choice	NDJ/G	80 - 140	0.05 - 0.1	0.05 - 0.1	0.05 - 0.1	0.1 - 0.2
	Carbon steel (C > 0.3) S45C / C45, S55C / C55, etc.	For low feed machines	NDL	50 - 100	-	0.03 - 0.1	0.03 - 0.12	-
		First choice	NDJ/G	80 - 140	0.05 - 0.16	0.05 - 0.16	0.05 - 0.2	0.1 - 0.2
M	Low alloy steel (C < 0.3) SCM415, 18CrMo4, etc.	For low feed machines	NDL	50 - 100	-	0.03 - 0.1	0.03 - 0.1	-
		First choice	NDJ/G	80 - 140	0.05 - 0.1	0.05 - 0.1	0.05 - 0.1	0.1 - 0.2
	Alloy steel (C > 0.3) SCM440 / 42CrMo4, SCr420 / 20Cr4, etc.	For low feed machines	NDL	50 - 100	-	0.03 - 0.1	0.03 - 0.12	-
		First choice	NDJ/G	80 - 120	0.05 - 0.16	0.05 - 0.16	0.05 - 0.2	0.1 - 0.2
K	Stainless steel (Austenitic) SUS304 / X5CrNi18-9, SUS316 / X5CrNiMo17-12-3, etc.	For low feed machines	NDL	50 - 100	-	0.03 - 0.06	0.03 - 0.06	-
		First choice	NDJ/G	60 - 100	0.05 - 0.1	0.05 - 0.1	0.05 - 0.1	0.1 - 0.15
	Stainless steel (Martensitic, Ferritic) SUS430 / X6Cr17, SUS416 / X12CrS13, etc.	For low feed machines	NDL	50 - 100	-	0.03 - 0.06	0.03 - 0.06	-
		First choice	NDJ/G	60 - 100	0.05 - 0.1	0.05 - 0.1	0.05 - 0.1	0.1 - 0.15
S	Stainless steel (Precipitation hard- ening) SUS630 / X5CrNiCuNb16-4, etc.	For low feed machines	NDL	50 - 100	-	0.03 - 0.06	0.03 - 0.06	-
		First choice	NDJ/G	60 - 100	0.05 - 0.1	0.05 - 0.1	0.05 - 0.1	0.1 - 0.15
	Grey cast iron FC250 / GG25 / 250, etc.	For low feed machines	NDL	50 - 100	-	0.03 - 0.15	0.05 - 0.18	-
		First choice	NDJ/G	80 - 140	0.05 - 0.25	0.05 - 0.25	0.05 - 0.3	0.1 - 0.3
N	Ductile cast iron FCD700 / 700-2, etc.	For low feed machines	NDL	50 - 100	-	0.03 - 0.15	0.05 - 0.18	-
		First choice	NDJ/G	80 - 140	0.05 - 0.25	0.05 - 0.25	0.05 - 0.3	0.1 - 0.3
	Aluminium alloys	For low feed machines	NDL	80 - 160	-	0.03 - 0.15	0.03 - 0.15	-
		First choice	NDJ/G	100 - 200	0.05 - 0.2	0.05 - 0.2	0.05 - 0.2	0.1 - 0.25
H	Heat-resistant alloys Inconel 718, etc.	For low feed machines	NDL	20 - 50	-	0.03 - 0.06	0.03 - 0.08	-
		First choice	NDJ/G	20 - 50	0.04 - 0.08	0.04 - 0.08	0.04 - 0.1	0.06 - 0.13
	Titanium alloys Ti-6Al-4V, etc.	For low feed machines	NDL	30 - 60	-	0.03 - 0.1	0.03 - 0.12	-
		First choice	NDJ/G	30 - 60	0.05 - 0.13	0.05 - 0.13	0.05 - 0.15	0.1 - 0.18
H	Hardened steel ≥ 40HRC	For low feed machines	NDL	40 - 100	-	0.03 - 0.08	0.03 - 0.08	-
		First choice	NDJ/G	50 - 100	0.04 - 0.08	0.04 - 0.08	0.04 - 0.1	0.06 - 0.13

APPLICATION RANGE

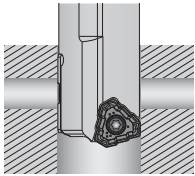
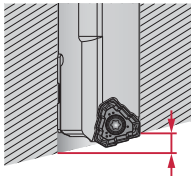
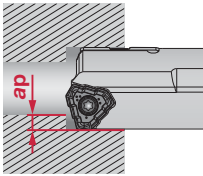
Feed f (mm/rev)	0.03 - 0.05	0.03 - 0.05	0.1 - 0.3
Application	OK Cross hole drilling 	OK Inclined exit  16 mm or less (for standard drill)	OK Boring 

Note 1) When drilling cross holes or exiting inclined surfaces, make sure the guide-pads are suitable.

Note 2) A pilot hole is needed prior to boring operations. $ap \geq 1$ mm is recommended for boring operations.

BLIND HOLE SHAPES OF THE HOLE BOTTOM

DC	Insert	Maximum difference	
		PL	
12 - 13.99	LOGT06	1.8	
14 - 15.99	TOHT07	2	
16 - 18	TOHT08	2.2	
18.01 - 20	TOHT09	3	
20.01 - 21.99	TOHT10	3.2	
22 - 25	TOHT11	3.4	
25.01 - 28	TOHT12	3.7	

LOGT06...

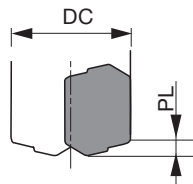

TOHT07..., 08...

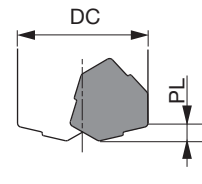

TOHT09... - TOHT12...

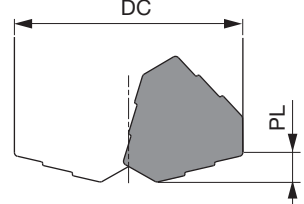

DC	Insert			Maximum difference PL
	Central	Intermediate	Peripheral	
28.01 - 29	FBM06504LG-C	FBM055/060**-I	FBH06003RG-P	2.6
29.01 - 29.99	FBM06504LG-C	FBM055/060**-I	FBH06003RG-P	2.6
30 - 31	FBM06504LG-C	FBM065/070**-I	FBH07504RG-P	2.9
31.01 - 32	FBM06504LG-C	FBM065/070**-I	FBH07504RG-P	3
32.01 - 33	FBM06504LG-C	FBM065/070**-I	FBH07504RG-P	3.1
33.01 - 34	FBM06504LG-C	FBM065/070**-I	FBH07504RG-P	3
34.01 - 35	FBM06504LG-C	FBM065/070**-I	FBH07504RG-P	3.1
35.01 - 36	FBM08004LG-C	FBM065/070**-I	FBH07504RG-P	3.1
36.01 - 37	FBM08004LG-C	FBM065/070**-I	FBH07504RG-P	3
37.01 - 38	FBM08004LG-C	FBM065/070**-I	FBH07504RG-P	3.1
38.01 - 39	FBM08004LG-C	FBM065/070**-I	FBH09004RG-P	3.4
39.01 - 40	FBM08004LG-C	FBM065/070**-I	FBH09004RG-P	3.3

FBM...

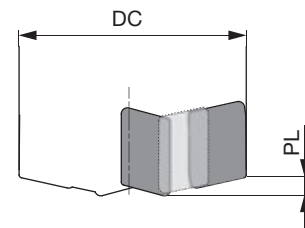

REQUIRED SPINDLE POWER AND COOLANT PRESSURE

Net power

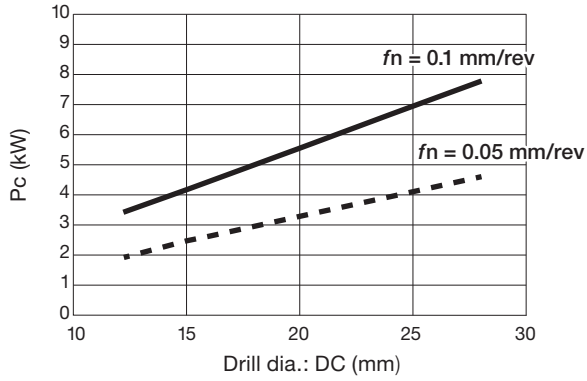

Torque

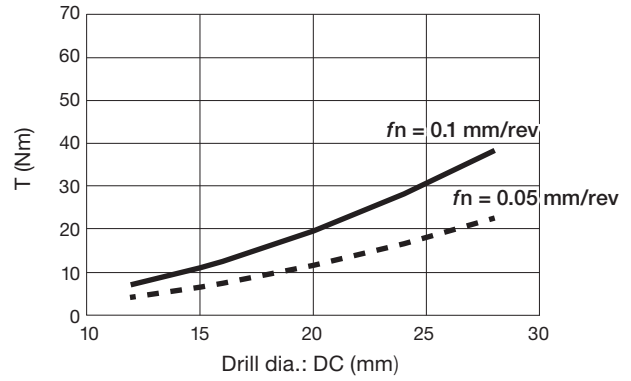

Net power

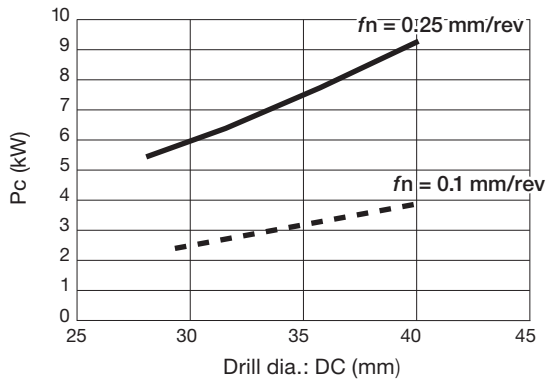

Torque

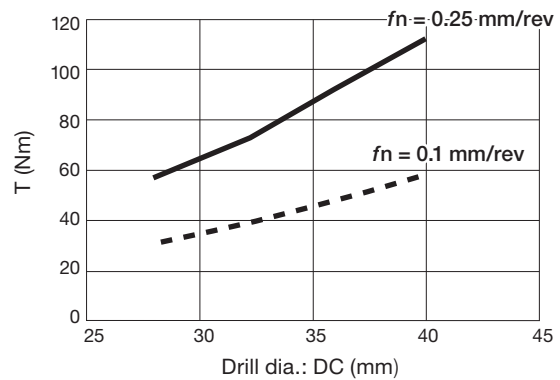

Coolant pressure

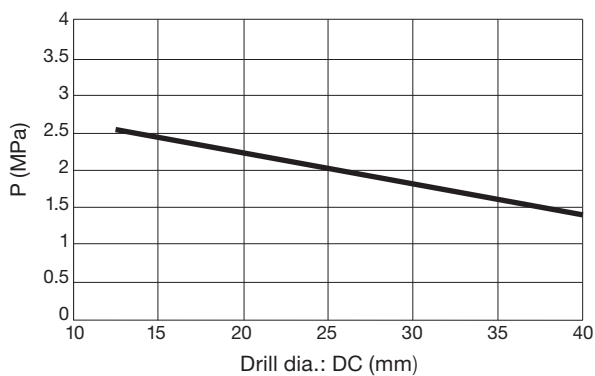

Coolant flow rate

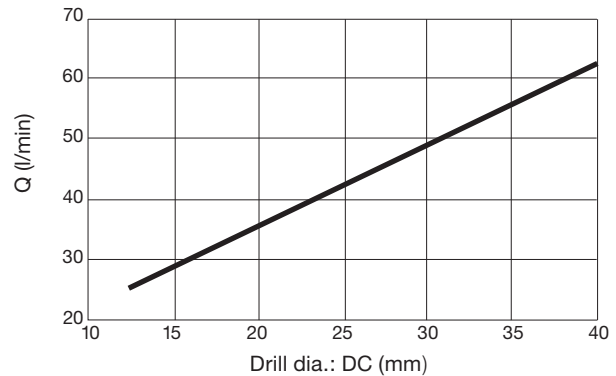

DRILLING PROCEDURE ON MACHINING CENTERS AND LATHES

Proceed as instructed below in order to maximize the tool performance.

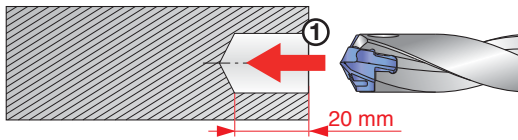

① Drill a pilot hole

Hole diameter tolerance: +0.01 - +0.1 mm

Hole depth: $H = 20$ mm

Please use DrillMeister or DrillForce-Meister for a pilot hole
Use a drill with 3xD or smaller

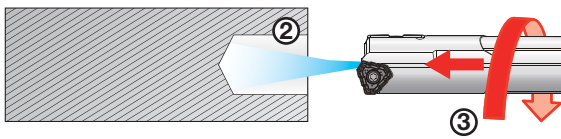

② Start coolant

③ Slowly insert DeepTri-Drill into the pilot hole

No. of revolution: $n = 50 - 100 \text{ min}^{-1}$

Feed rate: $V_f = 100 - 300 \text{ mm/min}$

Caution: Do not rotate the drill at full machining speed before engaging the pilot hole.

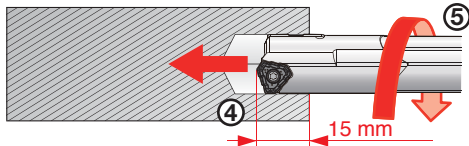

④ Stop the drill at 15 mm depth

⑤ Start rotating at full machining speed

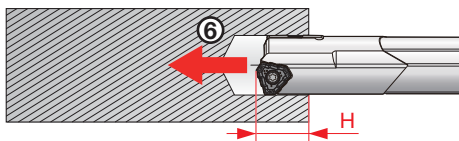

⑥ Start feeding

At the entry ($H = 15 - 25$ mm):

→ Feed: $f = 80\%$ of programmed feed

Hole depth:

$H \geq 25$ mm → Feed: $f = 100\%$

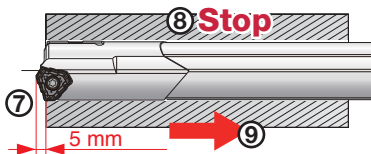

⑦ For a through hole

Continue drilling until the drill head passes through the workpiece by 5 mm

⑧ Stop the rotation and coolant

⑨ Return the drill, and operation finished

HOW TO USE A **TRLG** TYPE DEEPTRI-DRILL ON A HORIZONTAL MACHINING CENTER OR BORING MACHINE

When using the TRLG drill on a conventional machining center or horizontal boring machine where there are no drilling-bush supports available, a pilot hole needs to be made deeper with a MCTR drill to better support the long gundrill. A long gundrill such as the TRLG type drill tends to “whip” when the pilot hole is too short to support the gundrill.



① Drill a pilot hole

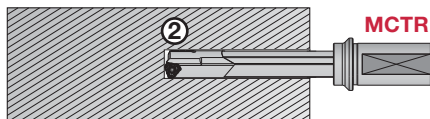

② Expand the pilot hole deeper using a MCTR drill

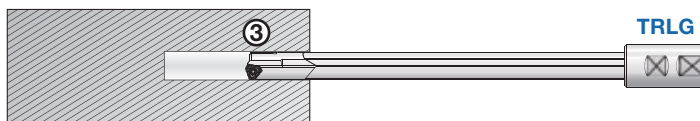

③ Drill with a TRLG drill at a reduced rotation and feed. Use the following parameters:

No. of revolution: $n = 50 - 100 \text{ min}^{-1}$
Feed speed: $V_f = 100 - 300 \text{ mm/min}$

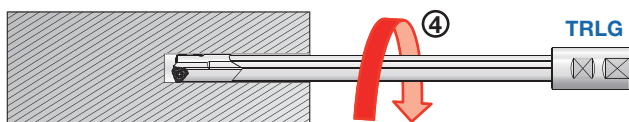

④ When DeepTri-Drill reaches all the way to the end of the pilot hole, increase drill rotation to full machining speed.



⑤ Start feeding to complete the drilling

(Caution)

Always use Step ② to prevent the gundrill from whipping, which may lead to drill breakage and a possible superfluous injury.

TOOL SELECTION WITH REGARD TO CROSS HOLE DIAMETERS AND DRILL DIAMETERS

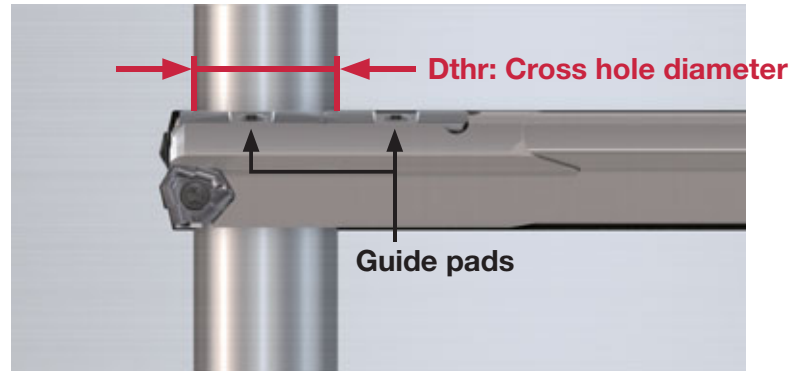
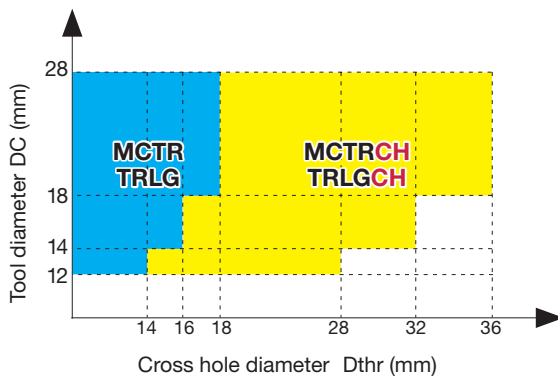

NC program for cross hole drilling

- Decrease the feed rate when the drill head comes in contact with a cross hole ($f = 0.03 - 0.05 \text{ mm/rev}$)
- Retract the gundrill with a slow rotation ($n = 100 \text{ min}^{-1}$, $V_f = 300 \text{ mm/min}$)
- When the gundrill is rapidly pulled out without rotating, the insert and/or guide pads may come in contact with burrs on the cross holes on the way back, resulting in damages



Designed for cross hole drilling

MYPACK SUPER CAM System offers a deep hole drilling program module for gun drills



Generates optimal programs to machine complex cross holes such as mold cooling channels. Allows improved cross-hole machining reliability as well as significant reduction of machining time

- Automatically recognizes crossing holes from given CAD models to calculate optimal feed rates
- Automatically controls feed rates when retracting the drill, greatly reducing the chance of tool breakage as well as optimizing drill retraction time
- Guide pad data of DeepTri-Drill is already registered in the system for operating convenience

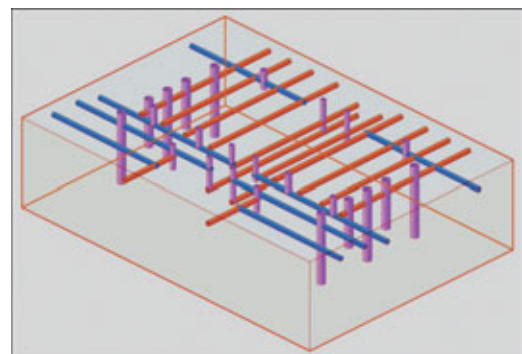

<http://www.kuraki.co.jp/solution/mypac/cam/machining/index.html> (Japanese only)
Please send inquiries to Kurashiki Kikai.

Deformation by centrifugal force

The gundrill is known to “whip” under certain circumstances. This is predicted on tool length and cutting speed. If the parameters are in the deforming zone as shown in the graph, consider amending the cutting speed or using an anti-whip guide.

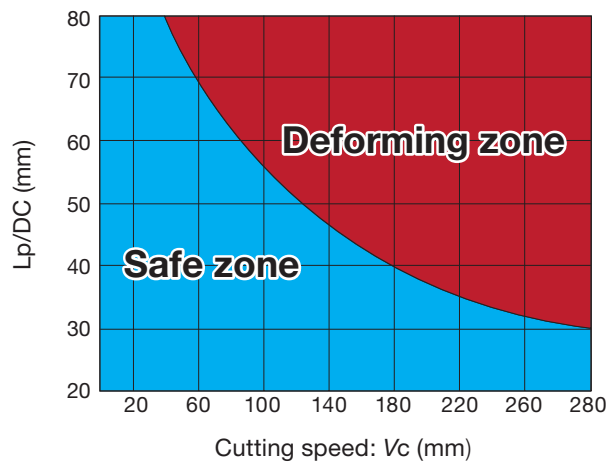
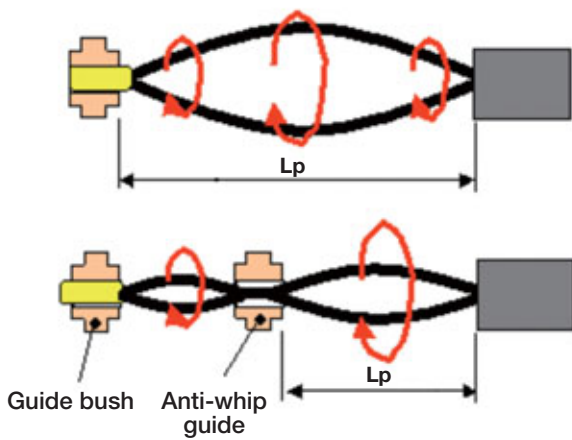

Recommended whip guide shape

A whip guide may be necessary for secure drilling.

A “Bearing and Gizmo bush is recommended*” for stable deep drilling.

* Gizmo whip guide is a trade mark of Gizmo

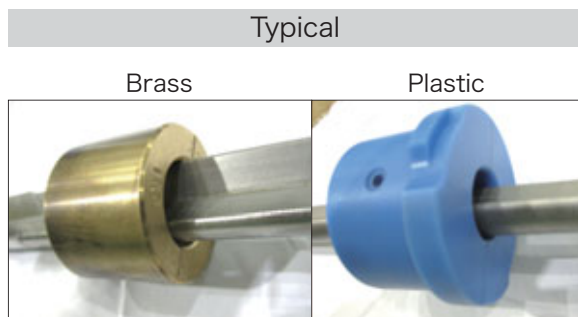

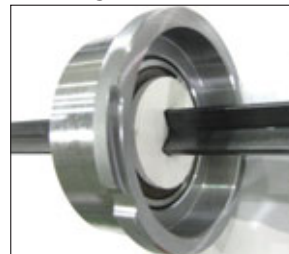

Recommendation

Bearing + Gizmo bush*

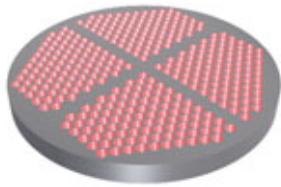
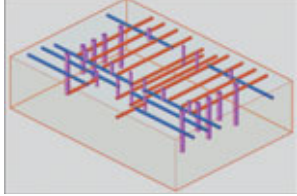
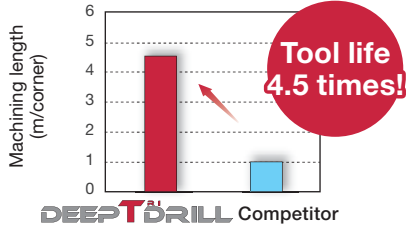
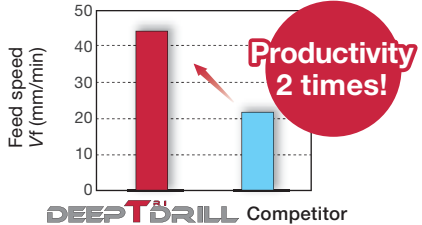

PRACTICAL EXAMPLES

Workpiece type		Tube Sheet	Plastic mold
Drill		MCTR20.00XM32-10	TRLGCH18.00X1500-36A
Insert		TOHT090305R-NDL	TOHT080305R-NDJ
Grade		AH725	AH725
Guide pad		GP06-085 F2122	GP06-075 F2122
Workpiece material		SUS304 / X5CrNi18-9	SKD61 / X40CrMoV5-1 (45 HRC)
			
Cutting conditions	Cutting speed: V_c (m/min)	80	62
	Feed : f (mm/rev)	0.04	0.04
	Feed speed : V_f (mm/min)	53	44
	Drilling depth : H (mm)	200	700
	Machine	Horizontal M/C	Horizontal M/C
Coolant		Wet	Wet
Results		 <p>The NDL style chipbreaker has improved chip control and provides stable machining. Extended tool life with machining stability.</p>	 <p>DeepTri-Drill has improved productivity and drilling stability with double the feed rate and eliminated premature tool failures. No need for regrinding worn drills, reducing tool inventory and management.</p>

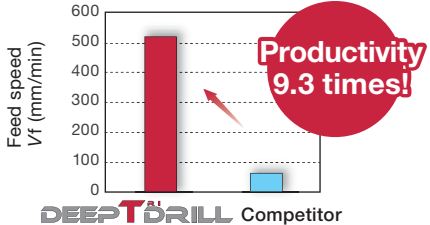
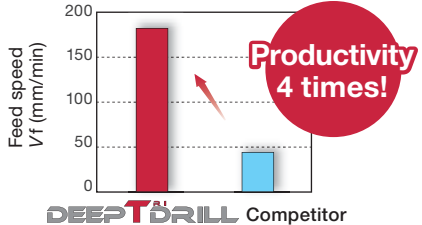
Workpiece type		Shaft	Axel shaft
Drill		MCTR12.00XM20-20	MCTR14.00XM25-15
Insert		LOGT060204R-NDJ	TOHT070304R-NDJ
Grade		AH725	AH725
Guide pad		GP04-055 F2122	GP05-060 F2122
Workpiece material		SCM420H	SCM435H
		 P	 P
Cutting conditions	Cutting speed: V_c (m/min)	150	80
	Feed : f (mm/rev)	0.13	0.1
	Feed speed : V_f (mm/min)	517	182
	Hole diameter: ϕD_c (mm)	12	14
	Drilling depth : H (mm)	233	200
	Machine	Vertical M/C	Lathe
Coolant		Wet	Internal
Results		 <p>Productivity 9.3 times!</p>	 <p>Productivity 4 times!</p>
		<p>DeepTri-Drill increases productivity by 9.3 times over the current brazed gundrill. No need for reconditioning.</p>	<p>Unlike the competitor's HSS drill, DeepTri-Drill does not require step feed and increases productivity by 4 times.</p>

Tungaloy Corporation (Head office)

11-1 Yoshima-Kogyodanchi
Iwaki-city, Fukushima 970-1144 Japan
Phone: +81-246-36-8501
Fax: +81-246-36-8542
www.tungaloy.co.jp

Tungaloy America, Inc.

3726 N Ventura Drive
Arlington Heights, IL 60004, U.S.A.
Phone: +1-888-554-8394
Fax: +1-888-554-8392
www.tungaloy.com/us

Tungaloy Canada

432 Elgin St. Unit 3
Brantford, Ontario N3S 7P7, Canada
Phone: +1-519-758-5779
Fax: +1-519-758-5791
www.tungaloy.com/ca

Tungaloy de Mexico S.A.

C Los Arellano 113,
Parque Industrial Siglo XXI
Aguascalientes, AGS, Mexico 20290
Phone: +52-449-929-5410
Fax: +52-449-929-5411
www.tungaloy.com/mx

Tungaloy do Brasil Ltda.

Avd. Independencia N4158 Residencial Flora
13280-000 Vinhedo, São Paulo, Brasil
Phone: +55-19-38262757
Fax: +55-19-38262757
www.tungaloy.com/br

Tungaloy Germany GmbH

An der Alten Ziegelei 1
D-40789 Monheim, Germany
Phone: +49-2173-90420-0
Fax: +49-2173-90420-19
www.tungaloy.de

Tungaloy France S.A.S.

ZA Courtaboef - Le Rio
1 rue de la Terre de feu
F-91952 Courtaboef Cedex, France
Phone: +33-1-6486-4300
Fax: +33-1-6907-7817
www.tungaloy.com/fr

Tungaloy Italia S.r.l.

Via E. Andolfato 10
I-20126 Milano, Italy
Phone: +39-02-252012-1
Fax: +39-02-252012-65
www.tungaloy.com/it

Tungaloy Czech s.r.o.

Turanka 115
CZ-627 00 Brno, Czech Republic
Phone: +420-532 123 391
Fax: +420-532 123 392
www.tungaloy.com/cz

Tungaloy Ibérica S.L.

C/Miquel Servet, 43B, Nau 7
Pol. Ind. Bufalvent
ES-08243 Manresa (BCN), Spain
Phone: +34 93 113 1360
Fax: +34 93 876 2798
www.tungaloy.com/es

Tungaloy Scandinavia AB

Bultgatan 38
442 40 Kungälv, Sweden
Phone: +46-462119200
Fax: +46-462119207
www.tungaloy.com/se

Tungaloy Rus, LLC

Andropova avenue, h.18/7,
11 floor, office 3, 115432,
Moscow, Russia
Phone: +7-499-683-01-80
Fax: +7-499-683-01-81
www.tungaloy.com/ru

Tungaloy Polska Sp. z o.o.

Ul. Irysowa 1, 55-040 Bielany
Wroclawskie, Poland
Phone: +48 607 907 237
www.tungaloy.com/pl

Tungaloy U.K. Ltd

Gallan Park, Watling Street,
Cannock, WS110XG, UK
Phone: +44 121 4000 231
Fax: +44 121 270 9694
www.tungaloy.com/uk

Tungaloy Hungary Kft

Erzsébet királyné útja 125
H-1142 Budapest, Hungary
Phone: +36 1 781-6846
Fax: +36 1 781-6866
www.tungaloy.com/hu

Tungaloy Turkey

Dudullu, OSB 4. Cad No:4
34776 Umraniye Istanbul, TURKEY
Phone: +90 216 540 04 67
Fax: +90 216 540 04 87
www.tungaloy.com/tr

Tungaloy Benelux b.v.

Tjalk 70
NL-2411 NZ Bodegraven, Netherlands
Phone: +31 172 630 420
Fax: +31 172 630 429
www.tungaloy.com/nl

Tungaloy Croatia

Ulica bana Josipa Jelačića 87,
10430, Samobor, Croatia
Phone: +385 1 3326 604
Fax: +385 1 3327 683
www.tungaloy.com/hr

Tungaloy Cutting Tool (Shanghai) Co., Ltd.

Rm No 401 No.88 Zhabei
Jiangchang No.3 Rd
Shanghai 200436, China
Phone: +86-21-3632-1880
Fax: +86-21-3621-1918
www.tungaloy.com/cn

Tungaloy Cutting Tools (Taiwan) Co., Ltd.

9F, No.293, Zhongyang Rd,
Xinzhuang Dist, New Taipei City,
24251 Taiwan
Phone: +886-2-8521-9986
Fax: +886-2-8521-8935
www.tungaloy.com/tw

Tungaloy Cutting Tools (Thailand) Co., Ltd.

Interlink tower 4th Fl.
1858/5-7 Bangna-Trad Road
km.5 Bangna, Bangna, Bangkok 10260
Thailand
Phone: +66-2-751-5711
Fax: +66-2-751-5715
www.tungaloy.com/th

Tungaloy Singapore (Pte.), Ltd.

62 Ubi Road 1, #06-11 Oxley BizHub 2
Singapore 408734
Phone: +65-6391-1833
Fax: +65-6299-4557
www.tungaloy.com/sg

Tungaloy Vietnam

LE04.38, Lexington Residence
67 Mai Chi Tho St., Dist. 2,
Ho Chi Minh City, Vietnam
Phone: +84-2837406660
www.tungaloy.com/sg

Tungaloy India Pvt. Ltd.

Indiabulls Finance Centre,
Unit # 902-A, 9th Floor,
Tower 1, Senapati Bapat Marg,
Elphinstone Road (West),
Mumbai-400013, India
Phone: +91-22-6124-8804
Fax: +91-22-6124-8899
www.tungaloy.com/in

Tungaloy Korea Co., Ltd

#1312, Byucksan Digital Valley 5-cha
Beotkkot-ro 244, Geumcheon-gu
153-788 Seoul, Korea
Phone: +82-2-2621-6161
Fax: +82-2-6393-8952
www.tungaloy.com/kr

Tungaloy Malaysia Sdn Bhd

50 K-2, Kelana Mall, Jalan SS6/14
Kelana Jaya, 47301
Petaling Jaya, Selangor Darul Ehsan
Malaysia
Phone: +603-7805-3222
Fax: +603-7804-8563
www.tungaloy.com/my

Tungaloy Australia Pty Ltd

Unit 68 1470 Ferntree Gully Road
Knoxfield 3180 Victoria, Australia
Phone: +61-3-9755-8147
Fax: +61-3-9755-6070
www.tungaloy.com/au

PT. Tungaloy Indonesia

Kompleks Grand Wisata Block AA-10 No.3-5
Cibitung
Bekasi 17510, Indonesia
Phone: +62-21-8261-5808
Fax: +62-21-8261-5809
www.tungaloy.com/id



www.tungaloy.com

follow us at:

facebook.com/tungaloyjapan
twitter.com/tungaloyjapan
www.youtube.com/tungaloycorporation



AS9100 Certified
78006
2015.11.04
ISO14001 Certified
EC97J1123
1997.11.26

Distributed by:



FIND US ON THE CLOUD!
machingcloud.com

