

DrillLine



DRILLMEISTER

www.tungaloy.com

Tungaloy Report No. 412-G

High productive head-changeable drill
new DMC drill head available for added stability



INDUSTRY 4.0
FEED the SPEED!



ACCELERATED MACHINING

DrillLine

DRILLMEISTER



Stable performance, long tool life, and significant cost-saving are possible thanks to eliminated tool reconditioning and reduced inventory

www.tungaloy.com

Head-changeable drills for unparalleled tool life and machining performance

Changeable drill head provides stable and long tool life, while eliminating the need for tool reconditioning

Margin of DrillMeister drill tip

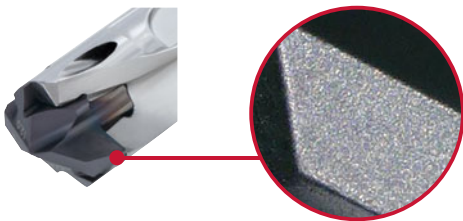

- Cutting head is always new and reliable
- Optimized coating thickness provides extended tool life
- Constant coating quality provides superior tool life predictability

Margin of solid carbide drill tip (after reconditionings)

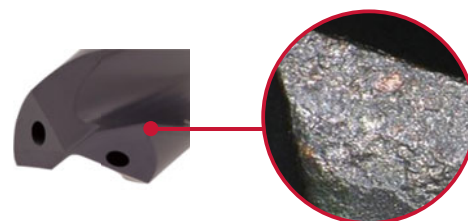

- Excess coating thickness due to multiple re-coating processes
- Fragile coating layer due to excess re-coating
- Result: unpredictable tool life

Tool life fluctuations of head-changeable tools

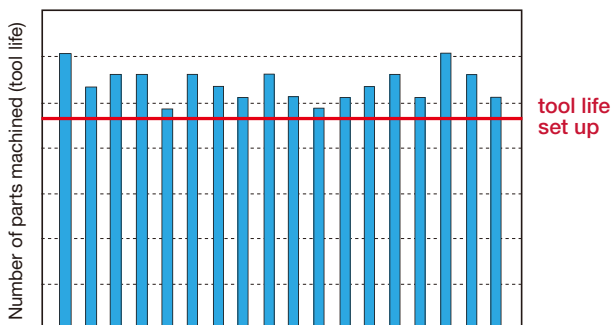

- Long and predictable tool life allows the tool change counter to be set at higher settings

Tool life fluctuations of solid carbide drills

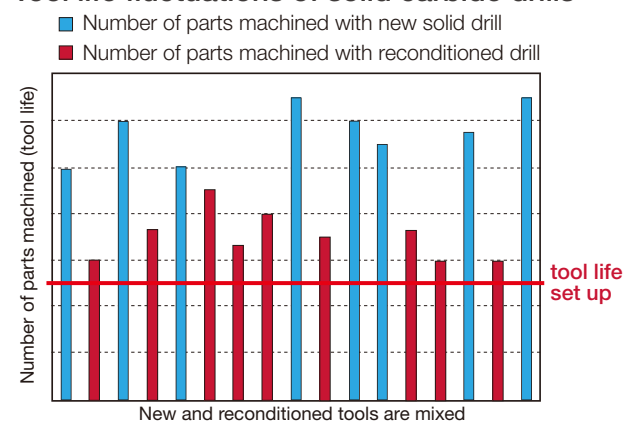

- Tool life prediction is set according to the lowest tool life

High accuracy, rigidity, and productivity

- Unique clamping structure provides high repeatability and reliability
- No refurbishing cost and reduced tool inventory requirements

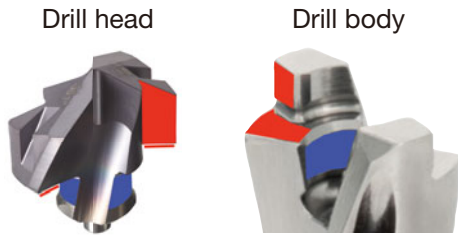

■ Contact area that supports the drill head against cutting force

■ Contact area that maintains the accurate drill position

Groove to prevent the head from falling off

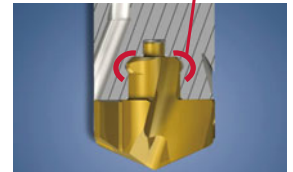

TID type shank

- Optimized helical flute design enables fast chip evacuation in deep hole drilling
- Ample supply of internal coolant is delivered through the twisted holes
- Longer shank lengths of the 3.5xD, 6xD, and 8xD cylindrical shank drills allow the drill overhang to be adjusted more freely than conventional drills when clamped in the tool holder.



Flanged shank

Cylindrical shank

Diameter range	L/D	Diameter range	L/D
ø6 - ø6.9	1.5, 3, 5	ø10 - ø19.9	3.5, 6, 8
ø7 - ø25.9	1.5, 3, 5, 8	ø8 - ø25.9	12

TIDC type shank

- The chamfering adapter can be mounted easily on the straight drill shank with no flange in the way

Diameter range	L/D
ø7.5 - ø19.9	3, 5

- **Drilling and chamfering in one shot**
Three different chamfering angles are available

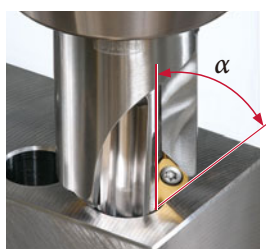

Enhanced drill head variations for higher performance

DMP Drill head - general purpose



- Versatile drill head
- Suited for various materials and applications
- Light cutting due to sharp cutting edge

Unique edge preparation

- Close-up of edges (new head)

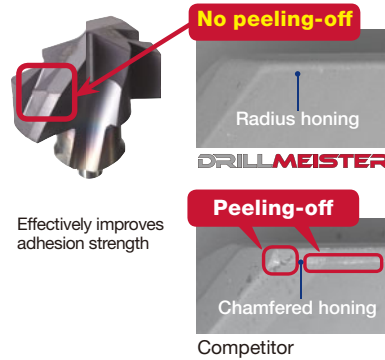

New DMC drill head - high accuracy drilling

Quick-centering profile

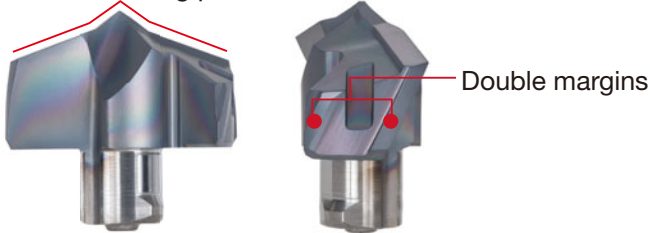

- Innovative chiseled edge for smooth drill entry. No pre-drilling needed in 12xD drilling operation
- Superior hole diameter accuracy and circularity
- Double margins provides superior surface finish and hole drilling straightness



Parameters : $V_c = 100$ m/min, $f = 0.3$ mm/rev
 Drill diameter : $\phi 13$, L/D = 12 (No pilot hole)
 Materials : S55C

Hole accuracy

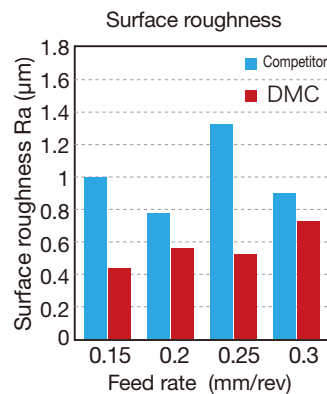
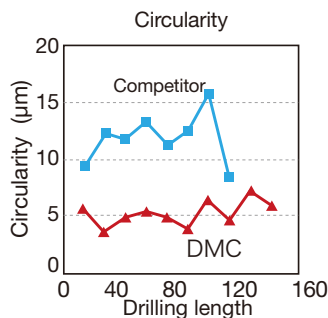
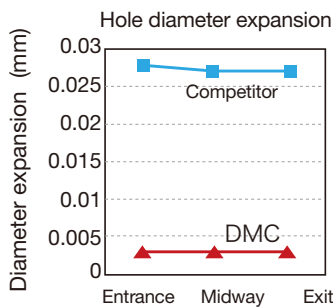

Cutting conditions: $V_c = 100$ m/min,
 $f = 0.25$ mm/rev
 Tool : $\phi 14$, L/D = 5
 Measured at : 30 mm
 Material : S55C

Latest coating optimized for extended tool life

New AH9130

- Unique nano-multilayered coating is made possible by Tungaloy's latest coating technology, providing 3 principal features

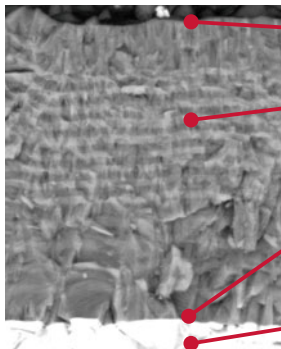

Feature 1: Resistance to builtup-edge

Coating layer to resist builtup-edge

Feature 2: Resistance to wear, oxidation, and fracture

2 coating layers for wear and oxidation resistance Layered alternatively to prevent crack from propagating to fracture

Feature 3: Strong coating-substrate adhesion

Coating is provided with strong adhesion between the coating layer and carbide substrate to prevent coating delamination

Substrate

Carbide substrate features wear and fracture resistance

Tool life in machining carbon steel (S55C / C55)

Tool life comparison

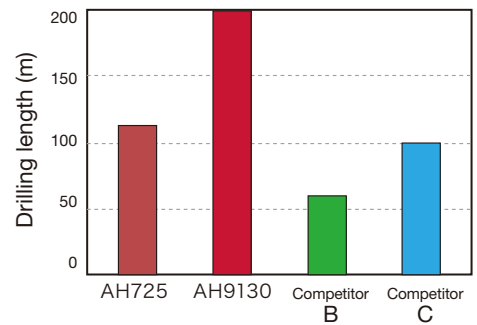

Tool : ϕ 14 mm, L/D = 5
 Workpiece : S55C / C55
 Cutting speed : $V_c = 100$ m/min
 Feed : $f = 0.25$ mm/rev
 Hole depth : $H = 60$ mm (Blind hole)

AH725 PREMIUMTEC

- Reliable PVD grade is suitable for various materials

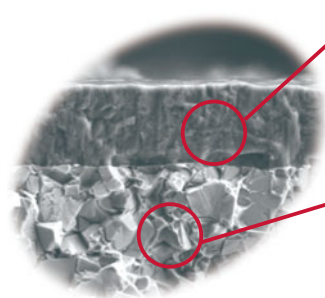

New coating layer drastically improves adhesion strength between the coating and the substrate.

Micro-grain alloy substrate provides plastic deformation resistance and toughness.

Tool life in machining carbon steel (S55C / C55)

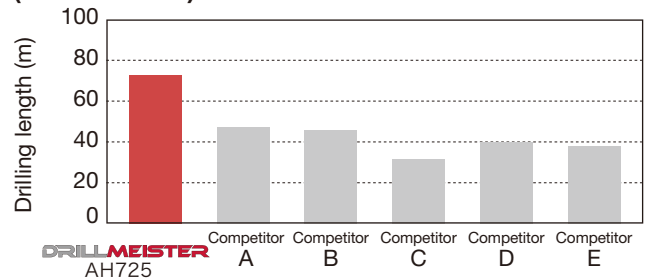

Tool : $\phi D_c = 12$ mm, L/D = 3
 Workpiece : S55C / C55
 Cutting speed : $V_c = 100$ m/min
 Feed : $f = 0.25$ mm/rev
 Hole depth : $H = 36$ mm (Blind hole)

Super flash coating

"Premiumtec" improves overall coating surface quality.

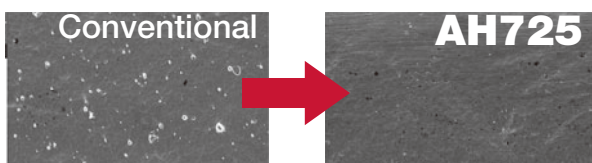

Tool life in machining ductile cast iron (FCD600 / 600-3)

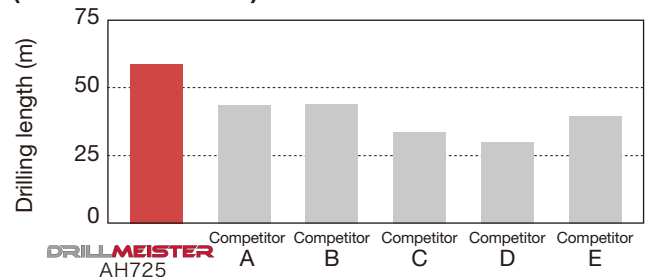

Tool : $\phi D_c = 12$ mm, L/D = 3
 Workpiece : FCD600 / 600-3
 Cutting speed: $V_c = 150$ m/min
 Feed : $f = 0.25$ mm/rev
 Hole depth : $H = 36$ mm (Blind hole)

TID-F L/D=1.5 Flanged shank

Head-changeable drill

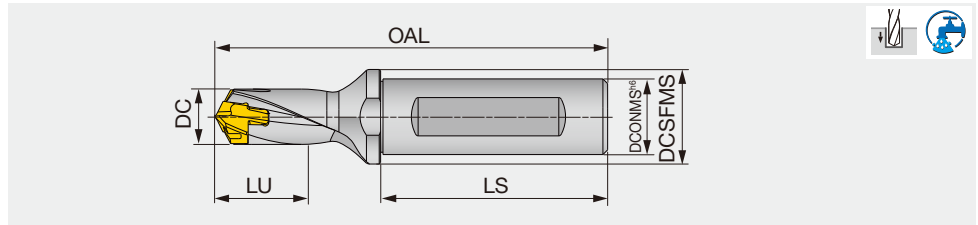

Designation	DC	DCONMS	DCSFMS	LU	LS	OAL		Pocket size	Head
						DMP	DMC		
TID060F12-1.5	6 - 6.4	12	16	10	45	68	68.2	6	DM*060-DM*064
TID065F12-1.5	6.5 - 6.9	12	16	11	45	69.1	69.6	6.5	DM*065-DM*069
TID070F12-1.5	7 - 7.4	12	16	12	45	70.1	70.3	7	DM*070-DM*074
TID075F12-1.5	7.5 - 7.9	12	16	13	45	70.9	71.1	7	DM*075-DM*079
TID080F12-1.5	8 - 8.9	12	16	14	45	72.4	73	8	DM*080-DM*089
TID090F12-1.5	9 - 9.9	12	16	16	45	74.3	74.9	9	DM*090-DM*099
TID100F16-1.5	10 - 10.9	16	20	17	48	79.2	79.8	10	DM*100 - DM*109
TID110F16-1.5	11 - 11.9	16	20	19	48	81.1	81.7	11	DM*110 - DM*119
TID120F16-1.5	12 - 12.9	16	20	20	48	83	83.6	12	DM*120 - DM*129
TID130F16-1.5	13 - 13.9	16	20	22	48	85.1	85.9	13	DM*130 - DM*139
TID140F16-1.5	14 - 14.9	16	20	24	48	89.1	89.9	14	DM*140 - DM*149
TID150F20-1.5	15 - 15.9	20	25	26	50	96.2	97.1	15	DM*150 - DM*159
TID160F20-1.5	16 - 16.9	20	25	27	50	99.3	100.3	16	DM*160 - DM*169
TID170F20-1.5	17 - 17.9	20	25	29	50	102.4	103.4	17	DM*170 - DM*179
TID180F25-1.5	18 - 18.9	25	32	30	56	111.5	112.6	18	DM*180 - DM*189
TID190F25-1.5	19 - 19.9	25	32	33	56	114.5	115.6	19	DM*190 - DM*199
TID200F25-1.5	20 - 20.9	25	32	34	56	117.6	118.8	20	DM*200 - DM*209
TID210F25-1.5	21 - 21.9	25	32	36	56	120.7	121.9	21	DM*210 - DM*219
TID220F25-1.5	22 - 22.9	25	32	37	56	123.8	125.1	22	DM*220 - DM*229
TID230F32-1.5	23 - 23.9	32	42	39	60	130.8	132.8	23	DM*230 - DM*239
TID240F32-1.5	24 - 24.9	32	42	40	60	133.9	135.3	24	DM*240 - DM*249
TID250F32-1.5	25 - 25.9	32	42	43	60	137	138.5	25	DM*250 - DM*259

Tool diameter	Hole diameter tolerance*
ø6 - ø25.9	+0.05 / 0

Notes : - An overall length (OAL) differs for when the DMP insert is mounted and when the DMC is mounted.
 - For drill diameters from ø8.0 mm - ø9.9 mm, the drill shoulder to shank bottom distance when a DMC drill head is mounted is 0.3 mm shorter when compared with a DMP head of the equivalent sizes. The distances are the same for the DMC and DMP drill heads in other diameters than the above.

SPARE PARTS

Designation	Clamping key
TID060-090	K-TID6-9.99
TID100-190	K-TID10-19.99
TID200-250	K-TID20-26.99

TID-F L/D=3 Flanged shank

Head-changeable drill

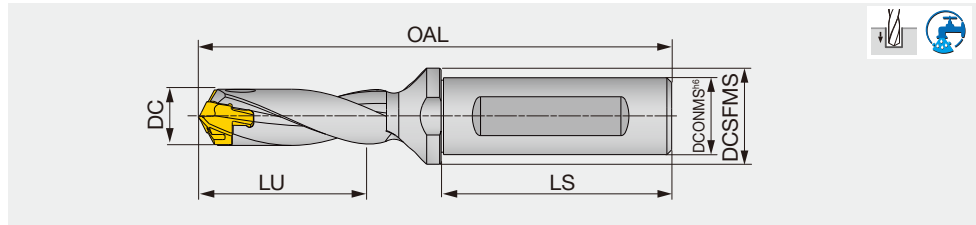

Designation	DC	DCONMS	DCSFMS	LU	LS	OAL		Pocket size	Head
						DMP	DMC		
TID060F12-3	6 - 6.4	12	16	19	45	77	77.2	6	DM*060-DM*064
TID065F12-3	6.5 - 6.9	12	16	21	45	78.8	79	6.5	DM*065-DM*069
TID070F12-3	7 - 7.4	12	16	22	45	80.6	81.1	7	DM*070-DM*074
TID075F12-3	7.5 - 7.9	12	16	24	45	82.1	82.6	7	DM*075-DM*079
TID080F12-3	8 - 8.4	12	16	26	45	84.4	84.6	8	DM*080-DM*084
TID085F12-3	8.5 - 8.9	12	16	28	45	85.9	86.1	8	DM*085-DM*089
TID090F12-3	9 - 9.4	12	16	29	45	87.8	88	9	DM*090-DM*094
TID095F12-3	9.5 - 9.9	12	16	31	45	89.3	89.5	9	DM*095-DM*099
TID100F16-3	10 - 10.4	16	20	32	48	94.2	94.8	10	DM*100 - DM*104
TID105F16-3	10.5 - 10.9	16	20	34	48	95.7	96.3	10	DM*105 - DM*109
TID110F16-3	11 - 11.4	16	20	35	48	97.6	98.2	11	DM*110 - DM*114
TID115F16-3	11.5 - 11.9	16	20	37	48	99.1	99.7	11	DM*115 - DM*119
TID120F16-3	12 - 12.4	16	20	38	48	101	101.6	12	DM*120 - DM*124
TID125F16-3	12.5 - 12.9	16	20	39	48	102.5	103.1	12	DM*125 - DM*129
TID130F16-3	13 - 13.4	16	20	41	48	104.6	105.4	13	DM*130 - DM*134
TID135F16-3	13.5 - 13.9	16	20	44	48	106.1	106.9	13	DM*135 - DM*139
TID140F16-3	14 - 14.4	16	20	45	48	110.1	110.9	14	DM*140 - DM*144
TID145F16-3	14.5 - 14.9	16	20	47	48	111.6	112.4	14	DM*145 - DM*149
TID150F20-3	15 - 15.9	20	25	48	50	118.7	119.6	15	DM*150 - DM*159
TID160F20-3	16 - 16.9	20	25	51	50	123.3	124.3	16	DM*160 - DM*169
TID170F20-3	17 - 17.9	20	25	54	50	127.9	128.9	17	DM*170 - DM*179
TID180F25-3	18 - 18.9	25	32	57	56	138.5	139.6	18	DM*180 - DM*189
TID190F25-3	19 - 19.9	25	32	61	56	143	144.1	19	DM*190 - DM*199
TID200F25-3	20 - 20.9	25	32	64	56	147.6	148.8	20	DM*200 - DM*209
TID210F25-3	21 - 21.9	25	32	67	56	152.2	153.4	21	DM*210 - DM*219
TID220F25-3	22 - 22.9	25	32	70	56	156.8	158.1	22	DM*220 - DM*229
TID230F32-3	23 - 23.9	32	42	73	60	165.3	166.7	23	DM*230 - DM*239
TID240F32-3	24 - 24.9	32	42	76	60	169.9	171.3	24	DM*240 - DM*249
TID250F32-3	25 - 25.9	32	42	80	60	174.5	176	25	DM*250 - DM*259

Tool diameter	Hole diameter tolerance*
ø6 - ø25.9	+0.05 / 0

Notes : - An overall length (OAL) differs for when the DMP insert is mounted and when the DMC is mounted.
 - For drill diameters from ø8.0 mm - ø9.9 mm, the drill shoulder to shank bottom distance when a DMC drill head is mounted is 0.3 mm shorter when compared with a DMP head of the equivalent sizes. The distances are the same for the DMC and DMP drill heads in other diameters than the above.

* Just for reference.



SPARE PARTS

Designation	Clamping key
TID060-095	K-TID6-9.99
TID100-190	K-TID10-19.99
TID200-250	K-TID20-26.99

TID-F L/D=5 Flanged shank

Head-changeable drill

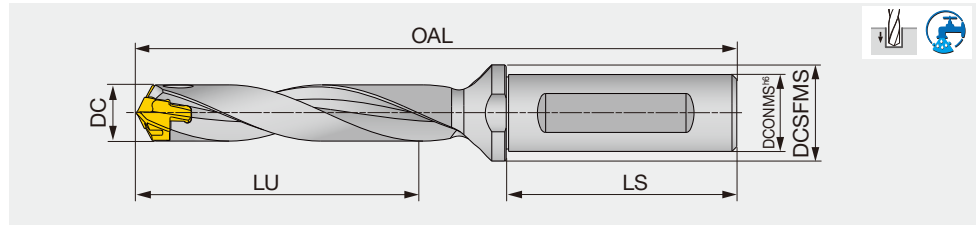

Designation	DC	DCONMS	DCSFMS	LU	LS	OAL		Pocket size	Head
						DMP	DMC		
TID060F12-5	6 - 6.4	12	16	31	45	89	89.2	6	DM*060-DM*064
TID065F12-5	6.5 - 6.9	12	16	34	45	91.8	92	6.5	DM*065-DM*069
TID070F12-5	7 - 7.4	12	16	36	45	94.6	95.1	7	DM*070-DM*074
TID075F12-5	7.5 - 7.9	12	16	39	45	97.1	97.6	7	DM*075-DM*079
TID080F12-5	8 - 8.4	12	16	42	45	100.4	100.6	8	DM*080-DM*084
TID085F12-5	8.5 - 8.9	12	16	45	45	102.9	103.1	8	DM*085-DM*089
TID090F12-5	9 - 9.4	12	16	47	45	105.8	106	9	DM*090-DM*094
TID095F12-5	9.5 - 9.9	12	16	50	45	108.3	108.5	9	DM*095-DM*099
TID100F16-5	10 - 10.4	16	20	52	48	114.2	114.8	10	DM*100 - DM*104
TID105F16-5	10.5 - 10.9	16	20	55	48	116.7	117.3	10	DM*105 - DM*109
TID110F16-5	11 - 11.4	16	20	57	48	119.6	120.2	11	DM*110 - DM*114
TID115F16-5	11.5 - 11.9	16	20	60	48	122.1	122.7	11	DM*115 - DM*119
TID120F16-5	12 - 12.4	16	20	62	48	125	125.6	12	DM*120 - DM*124
TID125F16-5	12.5 - 12.9	16	20	64	48	127.5	128.1	12	DM*125 - DM*129
TID130F16-5	13 - 13.4	16	20	67	48	130.6	131.4	13	DM*130 - DM*134
TID135F16-5	13.5 - 13.9	16	20	71	48	133.1	133.9	13	DM*135 - DM*139
TID140F16-5	14 - 14.4	16	20	73	48	138.2	139	14	DM*140 - DM*144
TID145F16-5	14.5 - 14.9	16	20	76	48	140.7	141.5	14	DM*145 - DM*149
TID150F20-5	15 - 15.9	20	25	78	50	148.7	149.6	15	DM*150 - DM*159
TID160F20-5	16 - 16.9	20	25	83	50	155.3	156.3	16	DM*160 - DM*169
TID170F20-5	17 - 17.9	20	25	88	50	161.9	162.9	17	DM*170 - DM*179
TID180F25-5	18 - 18.9	25	32	93	56	174.5	175.6	18	DM*180 - DM*189
TID190F25-5	19 - 19.9	25	32	99	56	181	182.1	19	DM*190 - DM*199
TID200F25-5	20 - 20.9	25	32	104	56	187.6	188.8	20	DM*200 - DM*209
TID210F25-5	21 - 21.9	25	32	109	56	194.2	195.4	21	DM*210 - DM*219
TID220F25-5	22 - 22.9	25	32	114	56	200.8	202.1	22	DM*220 - DM*229
TID230F32-5	23 - 23.9	32	42	119	60	211.3	212.7	23	DM*230 - DM*239
TID240F32-5	24 - 24.9	32	42	124	60	217.9	219.3	24	DM*240 - DM*249
TID250F32-5	25 - 25.9	32	42	130	60	224.5	226	25	DM*250 - DM*259

Tool diameter	Hole diameter tolerance*
ø6 - ø17.9	+0.06 / 0
ø18 - ø25.9	+0.065 / 0

Notes : · An overall length (OAL) differs for when the DMP insert is mounted and when the DMC is mounted.
 · For drill diameters from ø8.0 mm - ø9.9 mm, the drill shoulder to shank bottom distance when a DMC drill head is mounted is 0.3 mm shorter when compared with a DMP head of the equivalent sizes. The distances are the same for the DMC and DMP drill heads in other diameters than the above.

* Just for reference.

SPARE PARTS

Designation	Clamping key
TID060-095	K-TID6-9.99
TID100-190	K-TID10-19.99
TID200-250	K-TID20-26.99

TID-F L/D=8 Flanged shank

Head-changeable drill

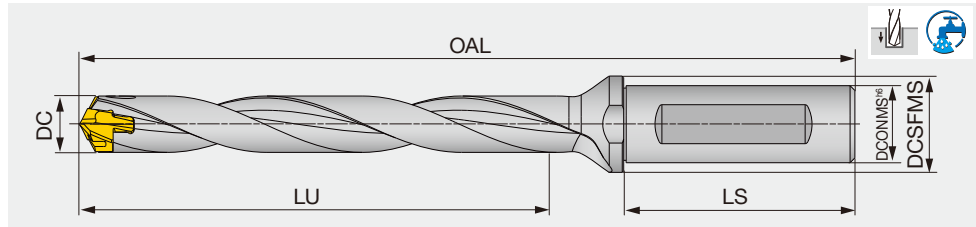

Designation	DC	DCONMS	DCSFMS	LU	LS	OAL		Pocket size	Head
						DMP	DMC		
TID070F12-8	7 - 7.4	12	16	57	45	115.6	115.8	7	DM*070-DM*074
TID075F12-8	7.5 - 7.9	12	16	61	45	119.6	119.8	7	DM*075-DM*079
TID080F12-8	8 - 8.4	12	16	66	45	124.4	124.9	8	DM*080-DM*084
TID085F12-8	8.5 - 8.9	12	16	70	45	128.4	128.9	8	DM*085-DM*089
TID090F12-8	9 - 9.4	12	16	74	45	132.8	133	9	DM*090-DM*094
TID095F12-8	9.5 - 9.9	12	16	78	45	136.8	137	9	DM*095-DM*099
TID100F16-8	10 - 10.4	16	20	82	48	144.2	144.4	10	DM*100 - DM*104
TID105F16-8	10.5 - 10.9	16	20	86	48	148.2	148.4	10	DM*105 - DM*109
TID110F16-8	11 - 11.4	16	20	90	48	152.6	153.2	11	DM*110 - DM*114
TID115F16-8	11.5 - 11.9	16	20	94	48	156.6	157.2	11	DM*115 - DM*119
TID120F16-8	12 - 12.4	16	20	98	48	161	161.6	12	DM*120 - DM*124
TID125F16-8	12.5 - 12.9	16	20	102	48	165	165.6	12	DM*125 - DM*129
TID130F16-8	13 - 13.4	16	20	106	48	169.6	170.2	13	DM*130 - DM*134
TID135F16-8	13.5 - 13.9	16	20	111	48	173.6	174.2	13	DM*135 - DM*139
TID140F16-8	14 - 14.4	16	20	115	48	180.1	180.9	14	DM*140 - DM*144
TID145F16-8	14.5 - 14.9	16	20	119	48	184.2	185	14	DM*145 - DM*149
TID150F20-8	15 - 15.9	20	25	123	50	193.7	194.5	15	DM*150 - DM*159
TID160F20-8	16 - 16.9	20	25	131	50	203.3	204.1	16	DM*160 - DM*169
TID170F20-8	17 - 17.9	20	25	139	50	212.9	213.8	17	DM*170 - DM*179
TID180F25-8	18 - 18.9	25	32	147	56	228.5	229.5	18	DM*180 - DM*189
TID190F25-8	19 - 19.9	25	32	156	56	238	239	19	DM*190 - DM*199
TID200F25-8	20 - 20.9	25	32	164	56	247.6	248.8	20	DM*200 - DM*209
TID210F25-8	21 - 21.9	25	32	172	56	257.2	258.4	21	DM*210 - DM*219
TID220F25-8	22 - 22.9	25	32	180	56	266.8	268.2	22	DM*220 - DM*229
TID230F32-8	23 - 23.9	32	42	188	60	280.3	281.7	23	DM*230 - DM*239
TID240F32-8	24 - 24.9	32	42	196	60	289.9	291.3	24	DM*240 - DM*249
TID250F32-8	25 - 25.9	32	42	205	60	299.5	301	25	DM*250 - DM*259

Tool diameter	Hole diameter tolerance*
ø7 - ø17.9	+0.07 / 0
ø18 - ø25.9	+0.085 / 0

Notes : An overall length (OAL) differs for when the DMP insert is mounted and when the DMC is mounted.

· For drill diameters from ø8.0 mm - ø9.9 mm, the drill shoulder to shank bottom distance when a DMC drill head is mounted is 0.3 mm shorter when compared with a DMP head of the equivalent sizes. The distances are the same for the DMC and DMP drill heads in other diameters than the above.

* Just for reference.



SPARE PARTS

Designation	Clamping key
TID060-095	K-TID6-9.99
TID100-190	K-TID10-19.99
TID200-250	K-TID20-26.99

New

TID-R L/D=3.5 Cylindrical shank

Head-changeable drill

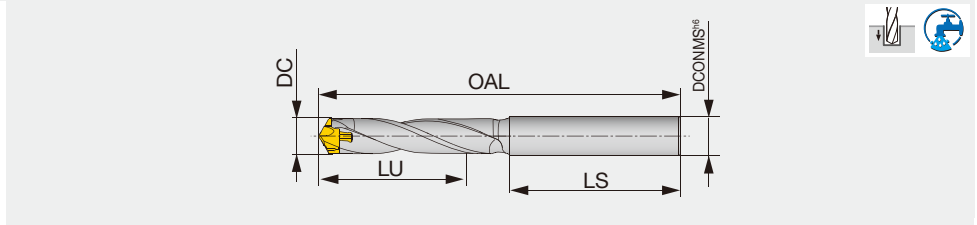

Designation	DC	DCONMS	LU	LS	OAL		Pocket size	Head
					DMP	DMC		
TID100R12-3.5	10 - 10.4	12	42	60	114.0	114.6	10	DM*100-DM*104
TID105R12-3.5	10.5 - 10.9	12	44	60	115.7	116.3	10	DM*105-DM*109
TID110R12-3.5	11 - 11.4	12	46	65	123.1	123.7	11	DM*110-DM*114
TID115R12-3.5	11.5 - 11.9	12	48	65	124.8	125.4	11	DM*115-DM*119
TID120R14-3.5	12 - 12.4	14	50	65	127.2	127.8	12	DM*120-DM*124
TID125R14-3.5	12.5 - 12.9	14	52	65	128.8	129.4	12	DM*125-DM*129
TID130R14-3.5	13 - 13.4	14	54	65	132.7	133.5	13	DM*130-DM*134
TID135R14-3.5	13.5 - 13.9	14	56	65	134.4	135.2	13	DM*135-DM*139
TID140R16-3.5	14 - 14.4	16	58	70	142.2	143.0	14	DM*140-DM*144
TID145R16-3.5	14.5 - 14.9	16	60	70	143.8	144.6	14	DM*145-DM*149
TID150R16-3.5	15 - 15.9	16	64	70	148.4	149.3	15	DM*150-DM*159
TID160R18-3.5	16 - 16.9	18	68	70	153.9	154.9	16	DM*160-DM*169
TID170R18-3.5	17 - 17.9	18	72	70	158.5	159.5	17	DM*170-DM*179
TID180R20-3.5	18 - 18.9	20	76	70	164.0	165.1	18	DM*180-DM*189
TID190R20-3.5	19 - 19.9	20	80	70	168.4	169.5	19	DM*190-DM*199

Tool diameter	Hole diameter tolerance*
ø8 - ø17.9	+0.08 / 0
ø18 - ø19.9	+0.095 / 0

Notes : - An overall length (OAL) differs for when the DMP insert is mounted and when the DMC is mounted.

(No difference for the drill shoulder)

· When using the drill at a higher feed rate, make sure to provide an axial support by placing the overhang adjusting screw at the drill shank end in the tool holder. This will prevent high thrust force from pushing the drill back into the holder during drilling.

· When axially adjusting the shank inside the holder to obtain a required drill overhang, make sure the shank length remaining inside the holder does not come short of the minimum clamping length (LSCN) specified by the holder supplier.

SPARE PARTS



Designation	Clamping key
TID060-095	K-TID6-9.99
TID100-190	K-TID10-19.99
TID200-220	K-TID20-26.99

New

TID-R L/D=6 Cylindrical shank

Head-changeable drill

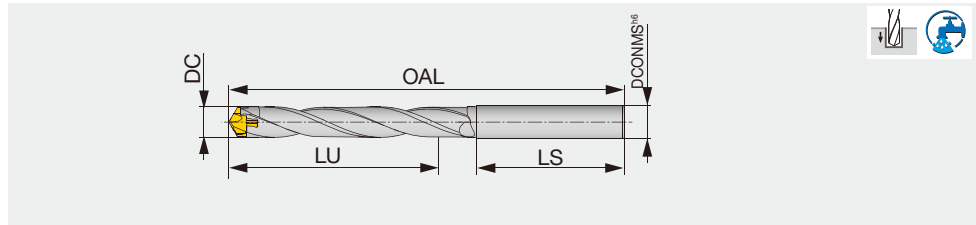

Designation	DC	DCONMS	LU	LS	OAL		Pocket size	Head
					DMP	DMC		
TID100R12-6	10 - 10.4	12	68	60	140.0	140.6	10	DM*100-DM*104
TID105R12-6	10.5 - 10.9	12	71	60	142.9	143.5	10	DM*105-DM*109
TID110R12-6	11 - 11.4	12	75	65	151.6	152.2	11	DM*110-DM*114
TID115R12-6	11.5 - 11.9	12	78	65	154.5	155.1	11	DM*115-DM*119
TID120R14-6	12 - 12.4	14	81	65	158.2	158.8	12	DM*120-DM*124
TID125R14-6	12.5 - 12.9	14	84	65	161.1	161.7	12	DM*125-DM*129
TID130R14-6	13 - 13.4	14	88	65	166.2	167.0	13	DM*130-DM*134
TID135R14-6	13.5 - 13.9	14	91	65	169.2	170.0	13	DM*135-DM*139
TID140R16-6	14 - 14.4	16	94	70	178.2	179.0	14	DM*140-DM*144
TID145R16-6	14.5 - 14.9	16	97	70	181.1	181.9	14	DM*145-DM*149
TID150R16-6	15 - 15.9	16	104	70	188.2	189.1	15	DM*150-DM*159
TID160R18-6	16 - 16.9	18	110	70	196.2	197.2	16	DM*160-DM*169
TID170R18-6	17 - 17.9	18	117	70	203.2	204.2	17	DM*170-DM*179
TID180R20-6	18 - 18.9	20	124	70	211.3	212.4	18	DM*180-DM*189
TID190R20-6	19 - 19.9	20	130	70	218.1	219.2	19	DM*190-DM*199

Tool diameter	Hole diameter tolerance*
ø8 - ø17.9	+0.08 / 0
ø18 - ø19.9	+0.095 / 0

* Just for reference.

Notes : · An overall length (OAL) differs for when the DMP insert is mounted and when the DMC is mounted.
(No difference for the drill shoulder)

- When using the drill at a higher feed rate, make sure to provide an axial support by placing the overhang adjusting screw at the drill shank end in the tool holder. This will prevent high thrust force from pushing the drill back into the holder during drilling.
- When axially adjusting the shank inside the holder to obtain a required drill overhang, make sure the shank length remaining inside the holder does not come short of the minimum clamping length (LSCN) specified by the holder supplier.

SPARE PARTS



Designation	Clamping key
TID060-095	K-TID6-9.99
TID100-190	K-TID10-19.99
TID200-220	K-TID20-26.99

New

TID-R L/D=8 Cylindrical shank

Head-changeable drill

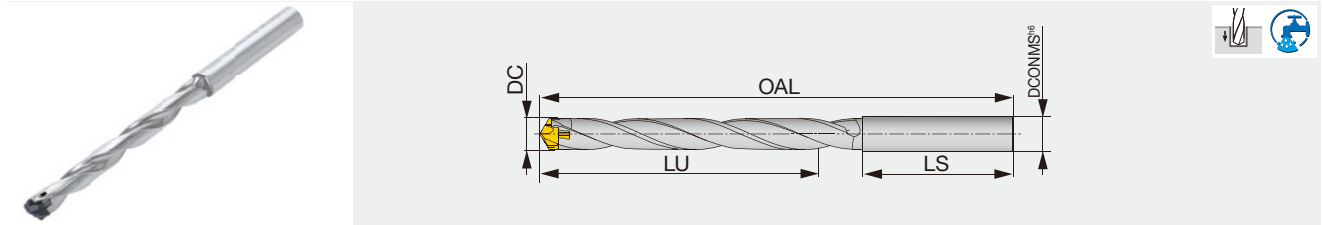

Designation	DC	DCONMS	LU	LS	OAL		Pocket size	Head
					DMP	DMC		
TID100R12-8	10 - 10.4	12	89	60	160.8	161.4	10	DM*100-DM*104
TID105R12-8	10.5 - 10.9	12	93	60	164.7	165.3	10	DM*105-DM*109
TID110R12-8	11 - 11.4	12	98	65	174.4	175.0	11	DM*110-DM*114
TID115R12-8	11.5 - 11.9	12	102	65	178.3	178.9	11	DM*115-DM*119
TID120R14-8	12 - 12.4	14	106	65	183.0	183.6	12	DM*120-DM*124
TID125R14-8	12.5 - 12.9	14	110	65	186.9	187.5	12	DM*125-DM*129
TID130R14-8	13 - 13.4	14	115	65	193.0	193.8	13	DM*130-DM*134
TID135R14-8	13.5 - 13.9	14	119	65	197.0	197.8	13	DM*135-DM*139
TID140R16-8	14 - 14.4	16	123	70	207.0	207.8	14	DM*140-DM*144
TID145R16-8	14.5 - 14.9	16	127	70	210.9	211.7	14	DM*145-DM*149
TID150R16-8	15 - 15.9	16	136	70	220.0	220.9	15	DM*150-DM*159
TID160R18-8	16 - 16.9	18	144	70	230.0	231.0	16	DM*160-DM*169
TID170R18-8	17 - 17.9	18	153	70	239.0	240.0	17	DM*170-DM*179
TID180R20-8	18 - 18.9	20	162	70	249.1	250.2	18	DM*180-DM*189
TID190R20-8	19 - 19.9	20	170	70	257.9	259.0	19	DM*190-DM*199

Tool diameter	Hole diameter tolerance*
ø8 - ø17.9	+0.08 / 0
ø18 - ø19.9	+0.095 / 0

* Just for reference.

Notes : · An overall length (OAL) differs for when the DMP insert is mounted and when the DMC is mounted.
(No difference for the drill shoulder)

- When using the drill at a higher feed rate, make sure to provide an axial support by placing the overhang adjusting screw at the drill shank end in the tool holder. This will prevent high thrust force from pushing the drill back into the holder during drilling.
- When axially adjusting the shank inside the holder to obtain a required drill overhang, make sure the shank length remaining inside the holder does not come short of the minimum clamping length (LSCN) specified by the holder supplier.

SPARE PARTS



Designation	Clamping key
TID060-095	K-TID6-9.99
TID100-190	K-TID10-19.99
TID200-220	K-TID20-26.99

TID-R L/D=12 Cylindrical shank

Head-changeable drill

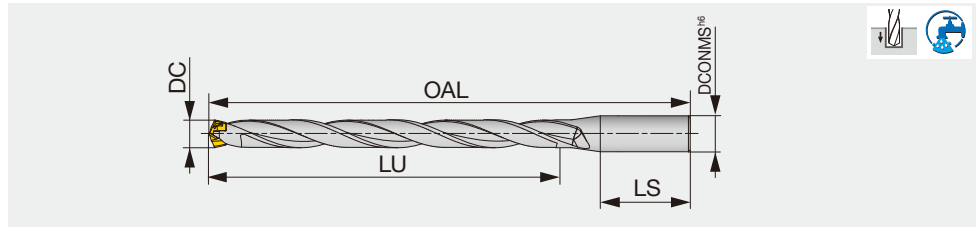

Designation	DC	DCONMS	LU	LS	OAL		Pocket size	Head
					DMP	DMC		
New TID080R12-12	8 - 8.4	12	98	45	156.4	156.6	8	DM*080-DM*084
New TID085R12-12	8.5 - 8.9	12	104	45	162.4	162.6	8	DM*085-DM*089
New TID090R12-12	9 - 9.4	12	110	45	168.8	169.3	9	DM*090-DM*094
New TID095R12-12	9.5 - 9.9	12	116	45	174.8	175.3	9	DM*095-DM*099
New TID100R16-12	10 - 10.4	16	122	48	184.2	184.4	10	DM*100-DM*104
New TID105R16-12	10.5 - 10.9	16	128	48	190.2	190.4	10	DM*105-DM*109
New TID110R16-12	11 - 11.4	16	134	48	196.6	196.8	11	DM*110-DM*114
TID115R16-12	11.5 - 11.9	16	140	48	202	202	11	DM*115-DM*119
TID120R16-12	12 - 12.4	16	146	48	209	209.6	12	DM*120 - DM*124
TID125R16-12	12.5 - 12.9	16	152	48	215	215.6	12	DM*125 - DM*129
TID130R16-12	13 - 13.4	16	158	48	221.6	222.2	13	DM*130 - DM*134
TID135R16-12	13.5 - 13.9	16	165	48	227.6	228.2	13	DM*135 - DM*139
TID140R16-12	14 - 14.4	16	171	48	236.2	236.8	14	DM*140 - DM*144
TID145R16-12	14.5 - 14.9	16	177	48	242.2	242.8	14	DM*145 - DM*149
TID150R20-12	15 - 15.9	20	183	50	253.7	254.5	15	DM*150 - DM*159
TID160R20-12	16 - 16.9	20	195	50	267.3	268.1	16	DM*160 - DM*169
TID170R20-12	17 - 17.9	20	207	50	280.9	281.7	17	DM*170 - DM*179
TID180R25-12	18 - 18.9	25	219	56	300.5	301.3	18	DM*180 - DM*189
TID190R25-12	19 - 19.9	25	232	56	314	314.9	19	DM*190 - DM*199
TID200R25-12	20 - 20.9	25	244	56	327.6	328.8	20	DM*200 - DM*209
TID210R25-12	21 - 21.9	25	256	56	341.2	342.4	21	DM*210 - DM*219
TID220R25-12	22 - 22.9	25	267	56	354.8	356.1	22	DM*220 - DM*229
TID230R32-12 ⁽¹⁾	23 - 23.9	32	276	60	372.3	373.7	23	DM*230 - DM*239
TID240R32-12 ⁽¹⁾	24 - 24.9	32	288	60	385.9	387.3	24	DM*240 - DM*249
TID250R32-12 ⁽¹⁾	25 - 25.9	32	300	60	399.5	401	25	DM*250 - DM*259

Tool diameter	Hole diameter tolerance*
ø8 - ø17.9	+0.08 / 0
ø18 - ø25.9	+0.095 / 0

* Just for reference.

Notes : -An overall length (OAL) differs for when the DMP insert is mounted and when the DMC is mounted.
 -When using the drill at a higher feed rate, make sure to provide an axial support by placing the overhang adjusting screw at the drill shank end in the tool holder. This will prevent high thrust force from pushing the drill back into the holder during drilling.
 - For drill diameters from ø8.0 mm - ø9.9 mm, the drill shoulder to shank bottom distance when a DMC drill head is mounted is 0.3 mm shorter when compared with a DMP head of the equivalent sizes. The distances are the same for the DMC and DMP drill heads in other diameters than the above.

(1) To be released in 2020

SPARE PARTS

Designation	Clamping key
TID060-095	K-TID6-9.99
TID100-190	K-TID10-19.99
TID200-220	K-TID20-26.99

TIDC L/D=3

Head-changeable drill

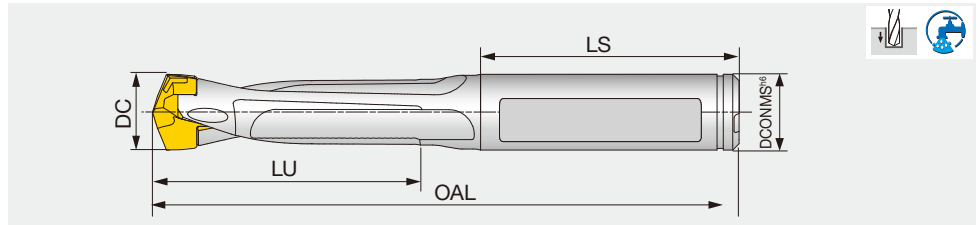

Designation	DC	DCONMS	LU	LS	OAL		Pocket size	Head
					DMP	DMC		
New TIDC075C8-3	7.5 - 7.9	8	23	36	70.1	70.6	7	DMP075-DMP079
New TIDC080C8-3	8 - 8.4	8	24	36	70.6	71.1	8	DMP080-DMP084
New TIDC085C9-3	8.5 - 8.9	9	26	36	72.8	73	8	DMP085-DMP089
New TIDC090C9-3	9 - 9.4	9	27	36	74.7	74.9	9	DMP090-DMP094
New TIDC095C10-3	9.5 - 9.9	10	29	36	76.2	76.4	9	DMP095-DMP099
TIDC100C10-3	10 - 10.4	10	32	41	86.1	86.7	10	DM*100 - DM*104
TIDC105C11-3	10.5 - 10.9	11	33	41	87.6	88.2	10	DM*105 - DM*109
TIDC110C11-3	11 - 11.4	11	35	41	89.5	90.1	11	DM*110 - DM*114
TIDC115C12-3	11.5 - 11.9	12	37	41	91	91.6	11	DM*115 - DM*119
TIDC120C12-3	12 - 12.4	12	38	41	92.8	93.4	12	DM*120 - DM*124
TIDC125C13-3	12.5 - 12.9	13	40	46	98.3	98.9	12	DM*125 - DM*129
TIDC130C13-3	13 - 13.4	13	41	47	102.4	103.2	13	DM*130 - DM*134
TIDC135C14-3	13.5 - 13.9	14	43	43	99.9	100.7	13	DM*135 - DM*139
TIDC140C14-3	14 - 14.4	14	45	44	103	103.8	14	DM*140 - DM*144
TIDC145C15-3	14.5 - 14.9	15	46	45	105.5	106.3	14	DM*145 - DM*149
TIDC150C15-3	15 - 15.9	15	48	45	107.5	108.4	15	DM*150 - DM*159
TIDC160C16-3	16 - 16.9	16	51	48	117.5	118.5	16	DM*160 - DM*169
TIDC170C17-3	17 - 17.9	17	54	48	119.7	120.7	17	DM*170 - DM*179
TIDC180C18-3	18 - 18.9	18	57	48	123.3	124.4	18	DM*180 - DM*189
TIDC190C19-3	19 - 19.9	19	61	54	132.4	133.5	19	DM*190 - DM*199

Tool diameter	Hole diameter tolerance*
ø7.5 - ø19.9	+0.05 / 0

* Just for reference.

- Notes:
- An overall length (OAL) differs for when the DMP insert is mounted and when the DMC is mounted.
 - When using the drill at a higher feed rate, make sure to provide an axial support by placing the overhang adjusting screw at the drill shank end in the tool holder. This will prevent high thrust force from pushing the drill back into the holder during drilling.
 - For drill diameters from ø8.0 mm - ø9.9 mm, the drill shoulder to shank bottom distance when a DMC drill head is mounted is 0.3 mm shorter when compared with a DMP head of the equivalent sizes. The distances are the same for the DMC and DMP drill heads in other diameters than the above.
 - When axially adjusting the shank inside the holder to obtain a required drill overhang, make sure the shank length remaining inside the holder does not come short of the minimum clamping length (LSCN) specified by the holder supplier.

SPARE PARTS



Designation	Clamping key
TIDC100-190	K-TID10-19.99

TIDC L/D=5

Head-changeable drill

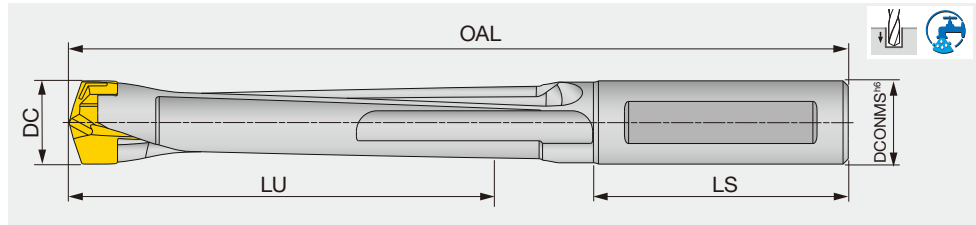

Designation	DC	DCONMS	LU	LS	OAL		Pocket size	Head
					DMP	DMC		
New TIDC075C8-5	7.5 - 7.9	8	38	36	85.1	85.6	7	DMP075-DMP079
New TIDC080C8-5	8 - 8.4	8	40	36	92.3	92.8	8	DMP080-DMP084
New TIDC085C9-5	8.5 - 8.9	9	43	36	89.8	90.0	8	DMP085-DMP089
New TIDC090C9-5	9 - 9.4	9	45	36	92.7	92.9	9	DMP090-DMP094
New TIDC095C10-5	9.5 - 9.9	10	48	36	95.2	95.4	9	DMP095-DMP099
TIDC100C10-5	10 - 10.4	10	52	41	106.1	106.7	10	DM*100 - DM*104
TIDC105C11-5	10.5 - 10.9	11	54	41	108.6	109.2	10	DM*105 - DM*109
TIDC110C11-5	11 - 11.4	11	57	41	111.5	112.1	11	DM*110 - DM*114
TIDC115C12-5	11.5 - 11.9	12	60	41	114	114.6	11	DM*115 - DM*119
TIDC120C12-5	12 - 12.4	12	62	41	116.8	117.4	12	DM*120 - DM*124
TIDC125C13-5	12.5 - 12.9	13	65	46	124.3	124.9	12	DM*125 - DM*129
TIDC130C13-5	13 - 13.4	13	67	47	128.4	129.2	13	DM*130 - DM*134
TIDC135C14-5	13.5 - 13.9	14	70	43	126.9	127.7	13	DM*135 - DM*139
TIDC140C14-5	14 - 14.4	14	73	44	131	131.8	14	DM*140 - DM*144
TIDC145C15-5	14.5 - 14.9	15	75	45	134.5	135.3	14	DM*145 - DM*149
TIDC150C15-5	15 - 15.9	15	78	45	137.5	138.4	15	DM*150 - DM*159
TIDC160C16-5	16 - 16.9	16	83	48	149.5	150.5	16	DM*160 - DM*169
TIDC170C17-5	17 - 17.9	17	88	48	153.7	154.7	17	DM*170 - DM*179
TIDC180C18-5	18 - 18.9	18	93	48	159.3	160.4	18	DM*180 - DM*189
TIDC190C19-5	19 - 19.9	19	99	54	170.4	171.5	19	DM*190 - DM*199

Tool diameter	Hole diameter tolerance*
ø7.5 - ø19.9	+0.05 / 0

* Just for reference.

- Notes :
- An overall length (OAL) differs for when the DMP insert is mounted and when the DMC is mounted.
 - When using the drill at a higher feed rate, make sure to provide an axial support by placing the overhang adjusting screw at the drill shank end in the tool holder. This will prevent high thrust force from pushing the drill back into the holder during drilling.
 - For drill diameters from ø8.0 mm - ø9.9 mm, the drill shoulder to shank bottom distance when a DMC drill head is mounted is 0.3 mm shorter when compared with a DMP head of the equivalent sizes. The distances are the same for the DMC and DMP drill heads in other diameters than the above.
 - When axially adjusting the shank inside the holder to obtain a required drill overhang, make sure the shank length remaining inside the holder does not come short of the minimum clamping length (LSCN) specified by the holder supplier.

SPARE PARTS

Designation	Clamping key
TIDC100-190	K-TID10-19.99



TIDCF

TIDC TYPE

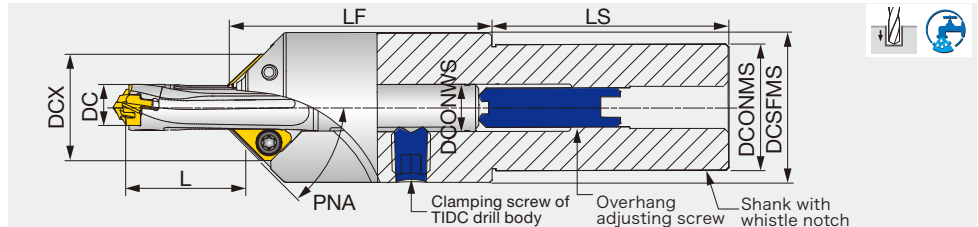

Designation	DC	DCONMS	DCSFMS	DCX	LF	LS	L* L/D = 3	L* L/D = 5	Drill body	DCONWS	Insert
New TIDCF080-W20	7.5 - 7.9	20	25	18.8	47.4	50	12.6 - 24	17.3 - 38	TIDC075C8-...	8	XCGT06...
New TIDCF080-W20	8.0 - 8.4	20	25	18.8	47.4	50	13.5 - 24.6	24.7 - 45	TIDC080C8-...	8	XCGT06...
New TIDCF090-W20	8.5 - 8.9	20	25	19.8	47.4	50	12.6 - 26.2	18.5 - 43	TIDC085C9-...	9	XCGT06...
New TIDCF090-W20	9.0 - 9.4	20	25	19.8	47.4	50	13 - 29.2	22.9 - 46.8	TIDC090C9-...	9	XCGT06...
TIDCF100-W32	9.5 - 9.9	32	38	24.9	67.3	60	12.9 - 27.8	26 - 47	TIDC095C10-...	10	XHG**09...
TIDCF100-W32	10 - 10.4	32	38	24.9	67.3	60	14.5 - 31.8	31.7 - 51.8	TIDC100C10-...	10	XHG**09...
TIDCF110-W32	10.5 - 10.9	32	38	25.9	67.3	60	15.7 - 33.3	31.2 - 54.2	TIDC105C11-...	11	XHG**09...
TIDCF110-W32	11 - 11.4	32	38	25.9	67.3	60	16.2 - 35.3	34.1 - 57.3	TIDC110C11-...	11	XHG**09...
TIDCF120-W32	11.5 - 11.9	32	38	26.9	67.3	60	15.1 - 36.7	33.8 - 59.4	TIDC115C12-...	12	XHG**09...
TIDCF120-W32	12 - 12.4	32	38	26.9	67.3	60	16.5 - 37.7	36.6 - 61.6	TIDC120C12-...	12	XHG**09...
TIDCF130-W32	12.5 - 12.9	32	38	27.9	67.3	60	16.1 - 39.6	39.7 - 64.8	TIDC125C13-...	13	XHG**09...
TIDCF130-W32	13 - 13.4	32	38	27.9	67.3	60	17.5 - 41.5	42.7 - 68	TIDC130C13-...	13	XHG**09...
TIDCF140-W32	13.5 - 13.9	32	38	28.4	67.3	60	17.7 - 42.9	41.4 - 70.3	TIDC135C14-...	14	XHG**09...
TIDCF140-W32	14 - 14.4	32	38	28.4	67.3	60	18.1 - 45	44.8 - 73.1	TIDC140C14-...	14	XHG**09...
TIDCF150-W32	14.5 - 14.9	32	38	29.4	67.3	60	19.2 - 44.6	44 - 73.9	TIDC145C15-...	15	XHG**09...
TIDCF150-W32	15 - 15.9	32	38	29.4	67.3	60	19.7 - 47.4	47.6 - 80.7	TIDC150C15-...	15	XHG**09...
TIDCF160-W32	16 - 16.9	32	38	30.4	67.3	60	19.5 - 55.3	57 - 87.5	TIDC160C16-...	16	XHG**09...
TIDCF170-W32	17 - 17.9	32	38	31.4	67.3	60	21.4 - 54.9	55.9 - 88.5	TIDC170C17-...	17	XHG**09...
TIDCF180-W32	18 - 18.9	32	38	32.4	67.3	60	24.2 - 65.2	60 - 93	TIDC180C18-...	18	XHG**09...
TIDCF190-W32	19 - 19.9	32	38	33.4	75	60	28.5 - 62.3	67 - 100	TIDC190C19-...	19	XHG**09...

• L* is the dimension when using 45° chamfering insert.

SPARE PARTS

Designation	Insert screw	Grip	Clamping screw of TIDC drill body	Overhang adjusting screw	Torx bit	Wrench	Wrench
TIDCF080-090	SR14-500/S	-	SRM6X6DIN916	SRM6X1.5S	-	HW3.0	T-8D
TIDCF100-190	SR14-544/S	SW6-SD	SRM10X10DIN916	SRM10X1.5S	BT15S	HW5.0	-

CHAMFERING INSERT

XHGT-30A

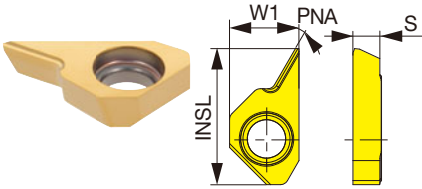

XHGR-45A

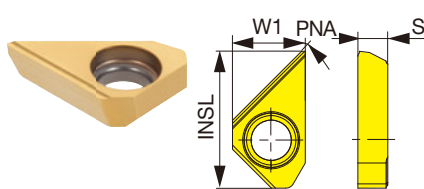

XHGR-60A

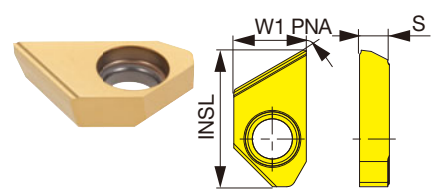

Designation	Grade GH730	INSL	W1	S	Chamfering angle	Maximum width of chamfer **
					PNA	
XCGT060300-30DT	●	12.3	6.18	2.8	30°	2
XCGT060300-45DT	●	12.3	6.18	2.8	45°	4
XCGT060300-60DT	●	12.3	6.18	2.8	60°	4
XHGT090300-30A	●	16	8.5	3.3	30°	3
XHGR090300-45A	●	16	8.5	3.3	45°	6
XHGR090300-60A	●	16	8.5	3.3	60°	6

** Please reduce the feed rate to half when chamfering over 60% of maximum width of chamfer

●: Line-up
Package quantity = 2 pcs.

DRILL HEAD

DMP

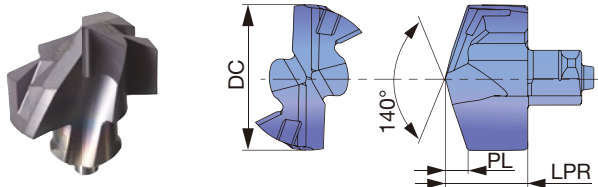

Tool diameter	ø6 - ø17.9	ø18 - ø25.9
Head diameter tolerance	+0.018 / 0	+0.021 / 0

Designation	DC	Grade		LPR	PL	Pocket size	Body	Designation	DC	Grade		LPR	PL	Pocket size	Body
		AH725	AH9130							AH725	AH9130				
DMP060	6	●		3.9	1.09	6	TID*060*	DMP100	10	●	●	6.1	1.47	10	TID*100*
DMP061	6.1	●		3.9	1.11	6	TID*060*	DMP101	10.1	●		6.1	1.49	10	TID*100*
DMP062	6.2	●		3.9	1.13	6	TID*060*	DMP102	10.2	●		6.1	1.51	10	TID*100*
DMP063	6.3	●		3.9	1.14	6	TID*060*	DMP103	10.3	●		6.1	1.52	10	TID*100*
DMP064	6.4	●		3.9	1.16	6	TID*060*	DMP104	10.4	●		6.1	1.54	10	TID*100*
DMP065	6.5	●		4.2	1.27	6.5	TID*065*	DMP105	10.5	●	●	6.1	1.56	10	TID*105*
DMP066	6.6	●		4.2	1.29	6.5	TID*065*	DMP106	10.6	●		6.1	1.58	10	TID*105*
DMP067	6.7	●		4.2	1.31	6.5	TID*065*	DMP107	10.7	●		6.1	1.6	10	TID*105*
DMP068	6.8	●		4.2	1.33	6.5	TID*065*	DMP108	10.8	●	●	6.1	1.62	10	TID*105*
DMP069	6.9	●		4.2	1.34	6.5	TID*065*	DMP109	10.9	●		6.1	1.63	10	TID*105*
DMP070	7	●		4.5	1.03	7	TID*070*	DMP110	11	●	●	6.5	1.67	11	TID*110*
DMP071	7.1	●		4.5	1.05	7	TID*070*	DMP111	11.1	●		6.5	1.69	11	TID*110*
DMP072	7.2	●		4.5	1.07	7	TID*070*	DMP112	11.2	●		6.5	1.71	11	TID*110*
DMP073	7.3	●		4.5	1.08	7	TID*070*	DMP113	11.3	●		6.5	1.72	11	TID*110*
DMP074	7.4	●		4.5	1.1	7	TID*070*	DMP114	11.4	●		6.5	1.74	11	TID*110*
DMP075	7.5	●		4.5	1.12	7	TID*075*	DMP115	11.5	●	●	6.5	1.76	11	TID*115*
DMP076	7.6	●		4.5	1.14	7	TID*075*	DMP116	11.6	●		6.5	1.78	11	TID*115*
DMP077	7.7	●		4.5	1.16	7	TID*075*	DMP117	11.7	●		6.5	1.8	11	TID*115*
DMP078	7.8	●		4.5	1.18	7	TID*075*	DMP118	11.8	●		6.5	1.82	11	TID*115*
DMP079	7.9	●		4.5	1.19	7	TID*075*	DMP119	11.9	●		6.5	1.83	11	TID*115*
DMP080	8	●		5.3	1.2	8	TID*080*	DMP120	12	●	●	6.8	1.82	12	TID*120*
DMP081	8.1	●		5.3	1.22	8	TID*080*	DMP121	12.1	●		6.8	1.84	12	TID*120*
DMP082	8.2	●		5.3	1.24	8	TID*080*	DMP122	12.2	●		6.8	1.86	12	TID*120*
DMP083	8.3	●		5.3	1.25	8	TID*080*	DMP123	12.3	●		6.8	1.87	12	TID*120*
DMP084	8.4	●		5.3	1.27	8	TID*080*	DMP124	12.4	●		6.8	1.89	12	TID*120*
DMP085	8.5	●		5.3	1.29	8	TID*085*	DMP125	12.5	●	●	6.8	1.91	12	TID*125*
DMP086	8.6	●		5.3	1.31	8	TID*085*	DMP126	12.6	●	●	6.8	1.93	12	TID*125*
DMP087	8.7	●		5.3	1.33	8	TID*085*	DMP127	12.7	●		6.8	1.95	12	TID*125*
DMP088	8.8	●		5.3	1.35	8	TID*085*	DMP128	12.8	●		6.8	1.97	12	TID*125*
DMP089	8.9	●		5.3	1.36	8	TID*085*	DMP129	12.9	●		6.8	1.98	12	TID*125*
DMP090	9	●		5.7	1.37	9	TID*090*	DMP130	13	●	●	7.4	1.96	13	TID*130*
DMP091	9.1	●		5.7	1.39	9	TID*090*	DMP131	13.1	●		7.4	1.98	13	TID*130*
DMP092	9.2	●		5.7	1.41	9	TID*090*	DMP132	13.2	●		7.4	2	13	TID*130*
DMP093	9.3	●		5.7	1.42	9	TID*090*	DMP133	13.3	●		7.4	2.01	13	TID*130*
DMP094	9.4	●		5.7	1.44	9	TID*090*	DMP134	13.4	●		7.4	2.03	13	TID*130*
DMP095	9.5	●		5.7	1.46	9	TID*095*	DMP135	13.5	●	●	7.4	2.05	13	TID*135*
DMP096	9.6	●		5.7	1.48	9	TID*095*	DMP136	13.6	●		7.4	2.07	13	TID*135*
DMP097	9.7	●		5.7	1.5	9	TID*095*	DMP137	13.7	●		7.4	2.09	13	TID*135*
DMP098	9.8	●		5.7	1.52	9	TID*095*	DMP138	13.8	●	●	7.4	2.11	13	TID*135*
DMP099	9.9	●		5.7	1.53	9	TID*095*	DMP139	13.9	●		7.4	2.12	13	TID*135*

●: Line-up
 Package Quantity: ø6.0 - ø19.9 = 2 pcs.
 ø20 - ø25.9 = 1 pc.

Designation	DC	Grade		LPR	PL	Pocket size	Body	Designation	DC	Grade		LPR	PL	Pocket size	Body
		AH725	AH9130							AH725	AH9130				
DMP140	14	●	●	8	2.12	14	TID*140*	DMP180	18	●	●	10.3	2.73	18	TID*180*
DMP141	14.1	●		8	2.14	14	TID*140*	DMP181	18.1	●		10.3	2.75	18	TID*180*
DMP142	14.2	●	●	8	2.16	14	TID*140*	DMP182	18.2	●		10.3	2.77	18	TID*180*
DMP143	14.3	●		8	2.17	14	TID*140*	DMP183	18.3	●		10.3	2.78	18	TID*180*
DMP144	14.4	●		8	2.19	14	TID*140*	DMP184	18.4	●		10.3	2.8	18	TID*180*
DMP145	14.5	●	●	8	2.21	14	TID*145*	DMP185	18.5	●	●	10.3	2.82	18	TID*180*
DMP146	14.6	●		8	2.23	14	TID*145*	DMP186	18.6	●		10.3	2.84	18	TID*180*
DMP147	14.7	●		8	2.25	14	TID*145*	DMP187	18.7	●		10.3	2.86	18	TID*180*
DMP148	14.8	●		8	2.27	14	TID*145*	DMP188	18.8	●		10.3	2.88	18	TID*180*
DMP149	14.9	●		8	2.28	14	TID*145*	DMP189	18.9	●		10.3	2.89	18	TID*180*
DMP150	15	●	●	8.5	2.27	15	TID*150*	DMP190	19	●	●	10.8	2.88	19	TID*190*
DMP151	15.1	●		8.5	2.29	15	TID*150*	DMP191	19.1	●		10.8	2.9	19	TID*190*
DMP152	15.2	●	●	8.5	2.31	15	TID*150*	DMP192	19.2	●		10.8	2.92	19	TID*190*
DMP153	15.3	●		8.5	2.32	15	TID*150*	DMP1927	19.27	●		10.8	2.93	19	TID*190*
DMP154	15.4	●		8.5	2.34	15	TID*150*	DMP193	19.3	●		10.8	2.93	19	TID*190*
DMP155	15.5	●	●	8.5	2.36	15	TID*150*	DMP194	19.4	●		10.8	2.95	19	TID*190*
DMP156	15.6	●		8.5	2.38	15	TID*150*	DMP195	19.5	●	●	10.8	2.97	19	TID*190*
DMP157	15.7	●		8.5	2.4	15	TID*150*	DMP196	19.6	●		10.8	2.99	19	TID*190*
DMP158	15.8	●	●	8.5	2.42	15	TID*150*	DMP197	19.7	●		10.8	3.01	19	TID*190*
DMP159	15.9	●		8.5	2.43	15	TID*150*	DMP198	19.8	●		10.8	3.03	19	TID*190*
DMP160	16	●	●	9.1	2.42	16	TID*160*	DMP199	19.9	●		10.8	3.04	19	TID*190*
DMP161	16.1	●		9.1	2.44	16	TID*160*	DMP200	20	●		11.4	3.02	20	TID*200*
DMP162	16.2	●		9.1	2.46	16	TID*160*	DMP201	20.1	●		11.4	3.04	20	TID*200*
DMP163	16.3	●		9.1	2.47	16	TID*160*	DMP202	20.2	●		11.4	3.06	20	TID*200*
DMP164	16.4	●		9.1	2.49	16	TID*160*	DMP203	20.3	●		11.4	3.07	20	TID*200*
DMP165	16.5	●	●	9.1	2.51	16	TID*160*	DMP204	20.4	●		11.4	3.09	20	TID*200*
DMP166	16.6	●		9.1	2.53	16	TID*160*	DMP205	20.5	●		11.4	3.11	20	TID*200*
DMP167	16.7	●		9.1	2.55	16	TID*160*	DMP206	20.6	●		11.4	3.13	20	TID*200*
DMP168	16.8	●		9.1	2.57	16	TID*160*	DMP207	20.7	●		11.4	3.15	20	TID*200*
DMP169	16.9	●		9.1	2.58	16	TID*160*	DMP208	20.8	●		11.4	3.17	20	TID*200*
DMP170	17	●	●	9.7	2.59	17	TID*170*	DMP209	20.9	●		11.4	3.18	20	TID*200*
DMP171	17.1	●		9.7	2.61	17	TID*170*	DMP210	21	●		12	3.18	21	TID*210*
DMP172	17.2	●		9.7	2.63	17	TID*170*	DMP211	21.1	●		12	3.2	21	TID*210*
DMP173	17.3	●		9.7	2.64	17	TID*170*	DMP212	21.2	●		12	3.22	21	TID*210*
DMP174	17.4	●		9.7	2.66	17	TID*170*	DMP213	21.3	●		12	3.23	21	TID*210*
DMP175	17.5	●	●	9.7	2.68	17	TID*170*	DMP214	21.4	●		12	3.25	21	TID*210*
DMP176	17.6	●		9.7	2.7	17	TID*170*	DMP215	21.5	●		12	3.27	21	TID*210*
DMP177	17.7	●		9.7	2.72	17	TID*170*	DMP216	21.6	●		12	3.29	21	TID*210*
DMP178	17.8	●		9.7	2.74	17	TID*170*	DMP217	21.7	●		12	3.31	21	TID*210*
DMP179	17.9	●		9.7	2.75	17	TID*170*	DMP218	21.8	●		12	3.33	21	TID*210*

●: Line-up
 Package Quantity: ø6.0 - ø19.9 = 2 pcs.
 ø20 - ø25.9 = 1 pc.

Designation	DC	Grade		LPR	PL	Pocket size	Body	Designation	DC	Grade		LPR	PL	Pocket size	Body
		AH725	AH9130							AH725	AH9130				
DMP219	21.9	●		12	3.34	21	TID*210*	DMP258	25.8	●		14.3	3.95	25	TID*250*
DMP220	22	●		12.6	3.32	22	TID*220*	DMP259	25.9	●		14.3	3.96	25	TID*250*
DMP221	22.1	●		12.6	3.34	22	TID*220*								
DMP222	22.2	●		12.6	3.36	22	TID*220*								
DMP223	22.3	●		12.6	3.37	22	TID*220*								
DMP224	22.4	●		12.6	3.39	22	TID*220*								
DMP225	22.5	●		12.6	3.41	22	TID*220*								
DMP226	22.6	●		12.6	3.43	22	TID*220*								
DMP227	22.7	●		12.6	3.45	22	TID*220*								
DMP228	22.8	●		12.6	3.47	22	TID*220*								
DMP229	22.9	●		12.6	3.48	22	TID*220*								
DMP230	23	●		13.1	3.46	23	TID*230*								
DMP231	23.1	●		13.1	3.48	23	TID*230*								
DMP232	23.2	●		13.1	3.5	23	TID*230*								
DMP233	23.3	●		13.1	3.51	23	TID*230*								
DMP234	23.4	●		13.1	3.53	23	TID*230*								
DMP235	23.5	●		13.1	3.55	23	TID*230*								
DMP236	23.6	●		13.1	3.57	23	TID*230*								
DMP237	23.7	●		13.1	3.59	23	TID*230*								
DMP238	23.8	●		13.1	3.61	23	TID*230*								
DMP239	23.9	●		13.1	3.62	23	TID*230*								
DMP240	24	●		13.7	3.62	24	TID*240*								
DMP241	24.1	●		13.7	3.64	24	TID*240*								
DMP242	24.2	●		13.7	3.66	24	TID*240*								
DMP243	24.3	●		13.7	3.67	24	TID*240*								
DMP244	24.4	●		13.7	3.69	24	TID*240*								
DMP245	24.5	●		13.7	3.71	24	TID*240*								
DMP246	24.6	●		13.7	3.73	24	TID*240*								
DMP247	24.7	●		13.7	3.75	24	TID*240*								
DMP248	24.8	●		13.7	3.77	24	TID*240*								
DMP249	24.9	●		13.7	3.78	24	TID*240*								
DMP250	25	●		14.3	3.8	25	TID*250*								
DMP251	25.1	●		14.3	3.82	25	TID*250*								
DMP252	25.2	●		14.3	3.84	25	TID*250*								
DMP253	25.3	●		14.3	3.85	25	TID*250*								
DMP254	25.4	●		14.3	3.87	25	TID*250*								
DMP255	25.5	●		14.3	3.89	25	TID*250*								
DMP256	25.6	●		14.3	3.91	25	TID*250*								
DMP2567	25.67	●		14.3	3.92	25	TID*250*								
DMP257	25.7	●		14.3	3.93	25	TID*250*								

●: Line-up
 Package Quantity: ø6.0 - ø19.9 = 2 pcs.
 ø20 - ø25.9 = 1 pc.

DMC

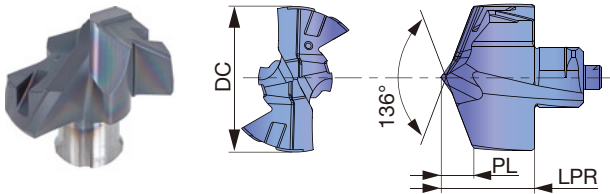

Tool diameter	ø6.0 - ø17.9	ø18 - ø25.67
Head diameter tolerance	+0.018 / 0	+0.021 / 0

Designation	DC	Grade AH9130	LPR	PL	Pocket size	Body	Designation	DC	Grade AH9130	LPR	PL	Pocket size	Body
DMC060	6.0	★	4	1.24	6	TID*060*	DMC100	10	●	6.7	2.09	10	TID*100*
DMC061	6.1	★	4	1.26	6	TID*060*	DMC101	10.1	●	6.7	2.11	10	TID*100*
DMC062	6.2	★	4	1.28	6	TID*060*	DMC102	10.2	●	6.7	2.13	10	TID*100*
DMC063	6.3	★	4	1.3	6	TID*060*	DMC103	10.3	●	6.7	2.15	10	TID*100*
DMC064	6.4	★	4	1.32	6	TID*060*	DMC104	10.4	●	6.7	2.17	10	TID*100*
DMC065	6.5	★	4.3	1.43	6.5	TID*065*	DMC105	10.5	●	6.7	2.19	10	TID*105*
DMC066	6.6	★	4.3	1.45	6.5	TID*065*	DMC106	10.6	●	6.7	2.21	10	TID*105*
DMC067	6.7	★	4.3	1.47	6.5	TID*065*	DMC107	10.7	●	6.7	2.23	10	TID*105*
DMC068	6.8	★	4.3	1.49	6.5	TID*065*	DMC108	10.8	●	6.7	2.25	10	TID*105*
DMC069	6.9	★	4.3	1.51	6.5	TID*065*	DMC109	10.9	●	6.7	2.27	10	TID*105*
DMC070	7.0	★	4.9	1.5	7	TID*070*	DMC110	11	●	7.1	2.32	11	TID*110*
DMC071	7.1	★	4.9	1.52	7	TID*070*	DMC111	11.1	●	7.1	2.34	11	TID*110*
DMC072	7.2	★	4.9	1.54	7	TID*070*	DMC112	11.2	●	7.1	2.36	11	TID*110*
DMC073	7.3	★	4.9	1.56	7	TID*070*	DMC113	11.3	●	7.1	2.38	11	TID*110*
DMC074	7.4	★	4.9	1.58	7	TID*070*	DMC114	11.4	●	7.1	2.4	11	TID*110*
DMC075	7.5	★	4.9	1.6	7	TID*075*	DMC115	11.5	●	7.1	2.42	11	TID*115*
DMC076	7.6	★	4.9	1.62	7	TID*075*	DMC116	11.6	●	7.1	2.44	11	TID*115*
DMC077	7.7	★	4.9	1.64	7	TID*075*	DMC117	11.7	●	7.1	2.46	11	TID*115*
DMC078	7.8	★	4.9	1.66	7	TID*075*	DMC118	11.8	●	7.1	2.48	11	TID*115*
DMC079	7.9	★	4.9	1.68	7	TID*075*	DMC119	11.9	●	7.1	2.5	11	TID*115*
DMC080	8.0	★	5.4	1.62	8	TID*080*	DMC120	12	●	7.4	2.45	12	TID*120*
DMC081	8.1	★	5.4	1.64	8	TID*080*	DMC121	12.1	●	7.4	2.47	12	TID*120*
DMC082	8.2	★	5.4	1.66	8	TID*080*	DMC122	12.2	●	7.4	2.49	12	TID*120*
DMC083	8.3	★	5.4	1.68	8	TID*080*	DMC123	12.3	●	7.4	2.51	12	TID*120*
DMC084	8.4	★	5.4	1.7	8	TID*080*	DMC124	12.4	●	7.4	2.53	12	TID*120*
DMC085	8.5	★	5.4	1.72	8	TID*085*	DMC125	12.5	●	7.4	2.55	12	TID*125*
DMC086	8.6	★	5.4	1.74	8	TID*085*	DMC126	12.6	●	7.4	2.57	12	TID*125*
DMC087	8.7	★	5.4	1.76	8	TID*085*	DMC127	12.7	●	7.4	2.59	12	TID*125*
DMC088	8.8	★	5.4	1.78	8	TID*085*	DMC128	12.8	●	7.4	2.61	12	TID*125*
DMC089	8.9	★	5.4	1.8	8	TID*085*	DMC129	12.9	●	7.4	2.63	12	TID*125*
DMC090	9.0	★	5.8	1.91	9	TID*090*	DMC130	13	●	8.2	2.71	13	TID*130*
DMC091	9.1	★	5.8	1.93	9	TID*090*	DMC131	13.1	●	8.2	2.73	13	TID*130*
DMC092	9.2	★	5.8	1.95	9	TID*090*	DMC132	13.2	●	8.2	2.75	13	TID*130*
DMC093	9.3	★	5.8	1.97	9	TID*090*	DMC133	13.3	●	8.2	2.77	13	TID*130*
DMC094	9.4	★	5.8	1.99	9	TID*090*	DMC134	13.4	●	8.2	2.79	13	TID*130*
DMC095	9.5	★	5.8	2.01	9	TID*095*	DMC135	13.5	●	8.2	2.81	13	TID*135*
DMC096	9.6	★	5.8	2.03	9	TID*095*	DMC136	13.6	●	8.2	2.83	13	TID*135*
DMC097	9.7	★	5.8	2.05	9	TID*095*	DMC137	13.7	●	8.2	2.85	13	TID*135*
DMC098	9.8	★	5.8	2.07	9	TID*095*	DMC138	13.8	●	8.2	2.87	13	TID*135*
DMC099	9.9	★	5.8	2.09	9	TID*095*	DMC139	13.9	●	8.2	2.89	13	TID*135*

★ : To be released in 2Q 2020 ● : Line-up
 Package Quantity: ø10 - ø19.9 = 2 pcs.

Designation	DC	Grade AH9130	LPR	PL	Pocket size	Body	Designation	DC	Grade AH9130	LPR	PL	Pocket size	Body
DMC140	14	●	8.8	2.93	14	TID*140*	DMC180	18	●	11.4	3.78	18	TID*180*
DMC141	14.1	●	8.8	2.95	14	TID*140*	DMC181	18.1	●	11.4	3.8	18	TID*180*
DMC142	14.2	●	8.8	2.97	14	TID*140*	DMC182	18.2	●	11.4	3.82	18	TID*180*
DMC143	14.3	●	8.8	2.99	14	TID*140*	DMC183	18.3	●	11.4	3.84	18	TID*180*
DMC144	14.4	●	8.8	3.01	14	TID*140*	DMC184	18.4	●	11.4	3.86	18	TID*180*
DMC145	14.5	●	8.8	3.03	14	TID*145*	DMC185	18.5	●	11.4	3.88	18	TID*180*
DMC146	14.6	●	8.8	3.05	14	TID*145*	DMC186	18.6	●	11.4	3.9	18	TID*180*
DMC147	14.7	●	8.8	3.07	14	TID*145*	DMC187	18.7	●	11.4	3.92	18	TID*180*
DMC148	14.8	●	8.8	3.09	14	TID*145*	DMC188	18.8	●	11.4	3.94	18	TID*180*
DMC149	14.9	●	8.8	3.11	14	TID*145*	DMC189	18.9	●	11.4	3.96	18	TID*180*
DMC150	15	●	9.4	3.18	15	TID*150*	DMC190	19	●	11.9	3.99	19	TID*190*
DMC151	15.1	●	9.4	3.2	15	TID*150*	DMC191	19.1	●	11.9	4.01	19	TID*190*
DMC152	15.2	●	9.4	3.22	15	TID*150*	DMC192	19.2	●	11.9	4.03	19	TID*190*
DMC153	15.3	●	9.4	3.24	15	TID*150*	DMC1927	19.27	●	11.9	4.04	19	TID*190*
DMC154	15.4	●	9.4	3.26	15	TID*150*	DMC193	19.3	●	11.9	4.05	19	TID*190*
DMC155	15.5	●	9.4	3.28	15	TID*150*	DMC194	19.4	●	11.9	4.07	19	TID*190*
DMC156	15.6	●	9.4	3.3	15	TID*150*	DMC195	19.5	●	11.9	4.09	19	TID*190*
DMC157	15.7	●	9.4	3.32	15	TID*150*	DMC196	19.6	●	11.9	4.11	19	TID*190*
DMC158	15.8	●	9.4	3.34	15	TID*150*	DMC197	19.7	●	11.9	4.13	19	TID*190*
DMC159	15.9	●	9.4	3.36	15	TID*150*	DMC198	19.8	●	11.9	4.15	19	TID*190*
DMC160	16	●	10.1	3.39	16	TID*160*	DMC199	19.9	★	11.9	4.17	19	TID*190*
DMC161	16.1	●	10.1	3.41	16	TID*160*	DMC200	20.0	★	12.6	4.2	20	TID*200*
DMC162	16.2	●	10.1	3.43	16	TID*160*	DMC205	20.5	★	12.6	4.31	20	TID*200*
DMC163	16.3	●	10.1	3.45	16	TID*160*	DMC210	21.0	★	13.2	4.41	21	TID*210*
DMC164	16.4	●	10.1	3.47	16	TID*160*	DMC215	21.5	★	13.2	4.52	21	TID*210*
DMC165	16.5	●	10.1	3.49	16	TID*160*	DMC220	22.0	★	13.8	4.62	22	TID*220*
DMC166	16.6	●	10.1	3.51	16	TID*160*	DMC225	22.5	★	13.8	4.72	22	TID*220*
DMC167	16.7	●	10.1	3.53	16	TID*160*	DMC230	23.0	★	14.5	4.83	23	TID*230*
DMC168	16.8	●	10.1	3.55	16	TID*160*	DMC235	23.5	★	14.5	4.93	23	TID*230*
DMC169	16.9	●	10.1	3.57	16	TID*160*	DMC240	24.0	★	15.1	5.04	24	TID*240*
DMC170	17	●	10.7	3.57	17	TID*170*	DMC245	24.5	★	15.1	5.14	24	TID*240*
DMC171	17.1	●	10.7	3.59	17	TID*170*	DMC250	25.0	★	15.8	5.25	25	TID*250*
DMC172	17.2	●	10.7	3.61	17	TID*170*	DMC255	25.5	★	15.8	5.35	25	TID*250*
DMC173	17.3	●	10.7	3.63	17	TID*170*	DMC2567	25.67	●	15.8	5.39	25	TID*250*
DMC174	17.4	●	10.7	3.65	17	TID*170*							
DMC175	17.5	●	10.7	3.67	17	TID*170*							
DMC176	17.6	●	10.7	3.69	17	TID*170*							
DMC177	17.7	●	10.7	3.71	17	TID*170*							
DMC178	17.8	●	10.7	3.73	17	TID*170*							
DMC179	17.9	●	10.7	3.75	17	TID*170*							

★ : To be released in 2Q 2020 ●: Line-up
 Package Quantity: ø10 - ø19.9 = 2 pcs.
 ø20 - ø25.9 = 1 pcs.

STANDARD CUTTING CONDITIONS

ISO	Workpiece materials	Cutting speed Vc (m/min)	Feed: f (mm/rev)						
			DC (mm)						
			ø6 - 7.9	ø8 - 9.9	ø10 - ø11.9	ø12 - ø13.9	ø14 - ø15.9	ø16 - ø19.9	ø20 - ø25.9
P	Low carbon steel (C < 0.3) (SS400 / St42-1, SM490 / St52-3, S25C / C25, etc.)	80 - 140	0.09 - 0.13	0.12 - 0.25	0.15 - 0.28	0.18 - 0.3	0.20 - 0.35	0.25 - 0.45	0.25 - 0.45
	High carbon steel (C > 0.3) (S45C / C45, S55C / C55, etc.)	70 - 120	0.09 - 0.13	0.12 - 0.25	0.15 - 0.28	0.18 - 0.3	0.2 - 0.35	0.25 - 0.45	0.25 - 0.45
	Low alloy steel (SCM415, etc.)	70 - 120	0.08 - 0.13	0.11 - 0.25	0.14 - 0.28	0.16 - 0.32	0.18 - 0.35	0.23 - 0.4	0.25 - 0.45
	Alloy steel (SCM440 / 42CrMo4, SCr420 / 20Cr4, etc.)	40 - 90	0.08 - 0.13	0.11 - 0.25	0.14 - 0.28	0.16 - 0.32	0.18 - 0.35	0.23 - 0.4	0.25 - 0.45
M	Stainless steel (SUS304 / X5CrNi18-9, SUS316 / X5CrNiMo17-12-2, etc.)	30 - 70	0.08 - 0.1	0.1 - 0.15	0.12 - 0.18	0.14 - 0.2	0.16 - 0.24	0.16 - 0.26	0.18 - 0.3
K	Grey cast iron (FC250 / GGG25, etc.)	80 - 180	0.12 - 0.18	0.15 - 0.3	0.20 - 0.35	0.25 - 0.4	0.3 - 0.45	0.35 - 0.55	0.35 - 0.6
	Ductile cast iron (FCD700 / GGG70, etc.)	80 - 140	0.12 - 0.18	0.15 - 0.3	0.20 - 0.35	0.25 - 0.4	0.3 - 0.45	0.35 - 0.55	0.35 - 0.6
N	Aluminium alloys (ADC12, etc.)	80 - 220	0.1 - 0.2	0.2 - 0.35	0.25 - 0.4	0.3 - 0.45	0.35 - 0.5	0.4 - 0.6	0.5 - 0.75
S	Titanium alloys (Ti-6Al-4V, etc.)	20 - 50	0.05 - 0.07	0.06 - 0.12	0.08 - 0.15	0.1 - 0.28	0.12 - 0.2	0.14 - 0.22	0.18 - 0.27
	Nickel-based alloys	20 - 50	0.05 - 0.07	0.06 - 0.11	0.08 - 0.13	0.1 - 0.15	0.12 - 0.18	0.12 - 0.22	0.14 - 0.22
H	Hardened steel	20 - 50	0.05 - 0.07	0.06 - 0.12	0.08 - 0.15	0.1 - 0.18	0.12 - 0.2	0.14 - 0.22	0.16 - 0.25

- Cutting conditions in the above table show standard cutting conditions.
- Cutting conditions may change due to the rigidity and power of the machine and the workpiece material.

- Machined hole diameter may change depending upon the rigidity of the machine tool or cutting conditions.
- In case of L/D = 8 & 12 drill, the recommended range of cutting speeds and feeds is between the minimum and median values listed above.

SPECIALLY-DESIGNED DRILL BODY

Special drill bodies, such as the one featuring chamfering or counter boring capabilities, will be available upon request. Please contact your sales representative for the details.

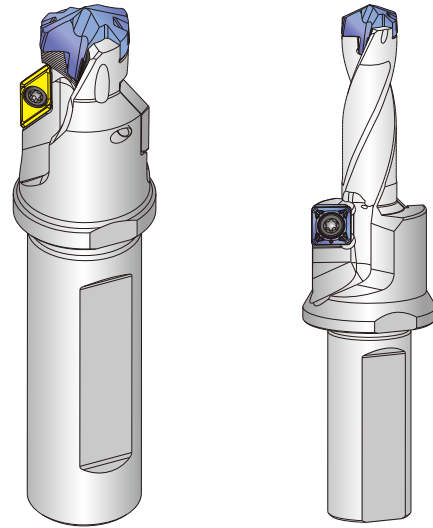

Typical components



Hub



Knuckle



Bearing caps



Brake disc



Tie rod



Steering rack part



Diff case



Crank shaft



Shafts



Turbine housing

HOW TO MOUNT THE TIDC DRILL BODY INTO THE CHAMFER ADAPTOR

The overhang length of the drill can be changed by the adjusting screw at the bottom of the adaptor.

The rear end of the drill body must be in contact with the adjusting screw as the screw supports the drill against thrust force when drilling.

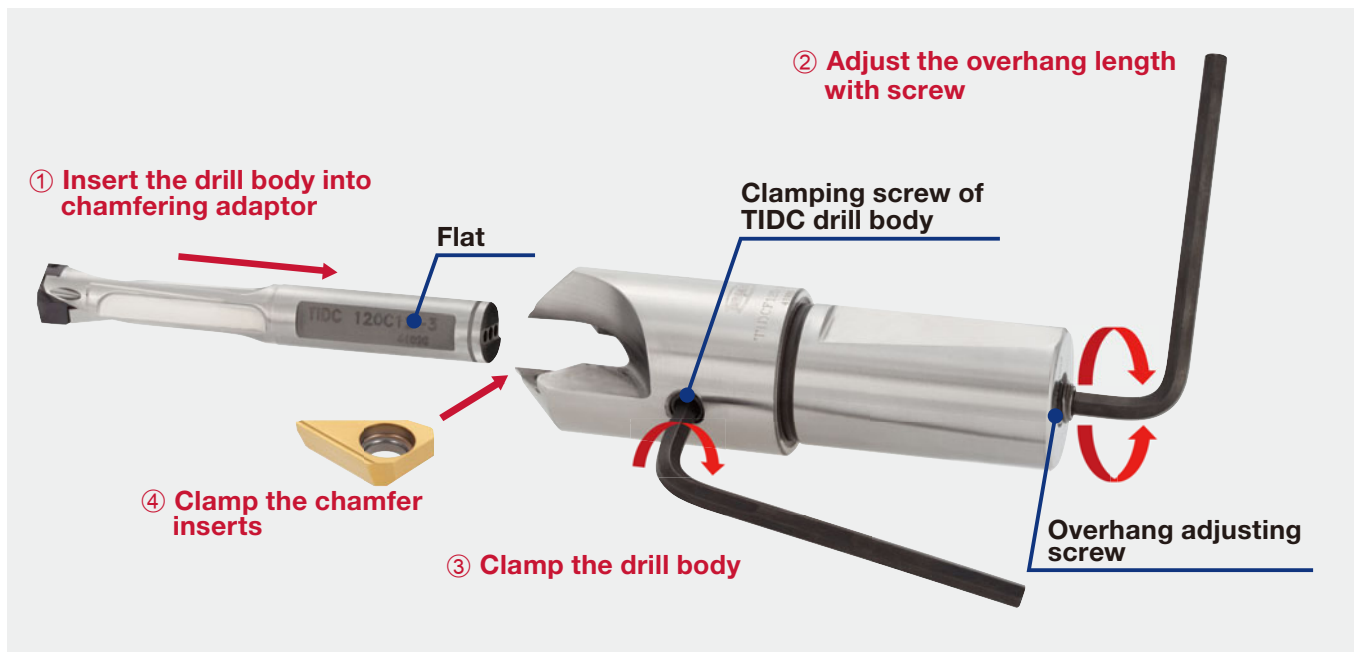

Procedure

- ① Place the TIDC drill body into the chamfer adaptor without chamfer inserts.
- ② Adjust the overhang length of the drill body with the adjusting screw at the bottom of the adaptor.
- ③ Adjust the position of the drill body so that the drill body is fixed at the flat and tighten the clamping screw of the drill body. This aligns the flutes of the TIDC drill body with the chamfer inserts.
- ④ To clamp the chamfer inserts, tighten the clamping screw of the insert while pushing the insert into the insert pocket.

Notice

Before removing the drill body from the adaptor, chamfer inserts must be unclamped. The overhang adjusting screw can be handled from the top of the adaptor with a flat-blade screwdriver. The overhang length of the drill body can be adjusted after the adaptor is positioned on the drill shank.

TECHNICAL GUIDELINES

● When to change drill heads (Criteria for the end of tool life)

The criteria to identify the time for tool change are as follows:

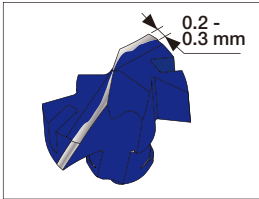

Width of corner wear reaches 0.2 – 0.3 mm.

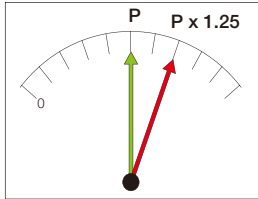

Spindle load exceeds 125% of the normal value.

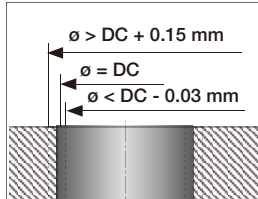

Hole diameter is 0.15 mm larger or 0.03 mm smaller than the drill diameter.

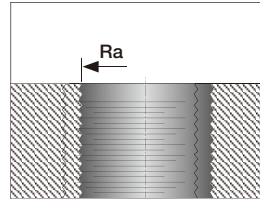

Surface roughness deteriorates.

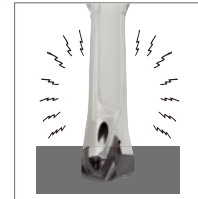

Vibration or unusual noise occurs.

● How to clamp the drill head

① Clean and lubricate the pocket.

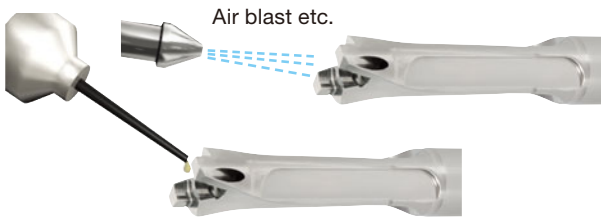

② Set the drill head into the pocket.



③ Set the clamping key on the drill head

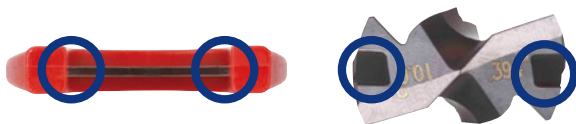

④ Clamp



● Coolant supply

Internal coolant supply is recommended.



■ The required coolant flow and pressure

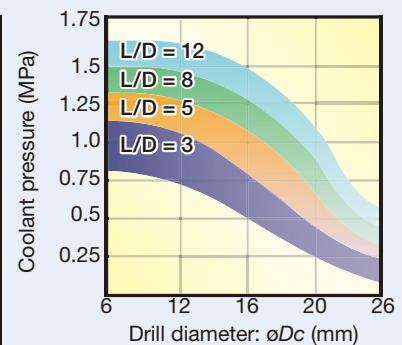
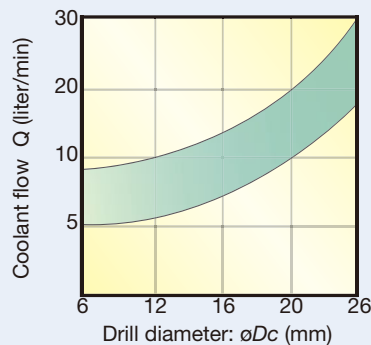

● Applications that are not recommended

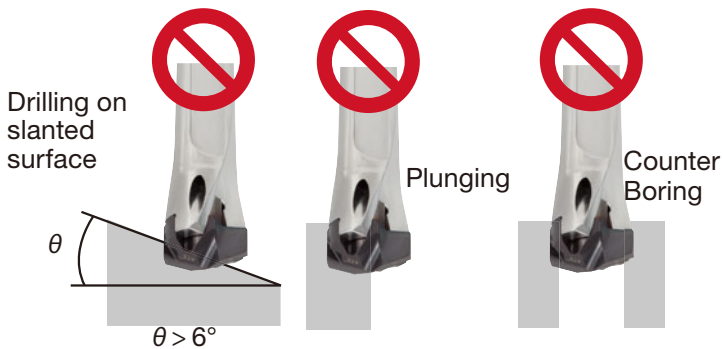

● Run-out

Run-out should be less than 0.02 mm.

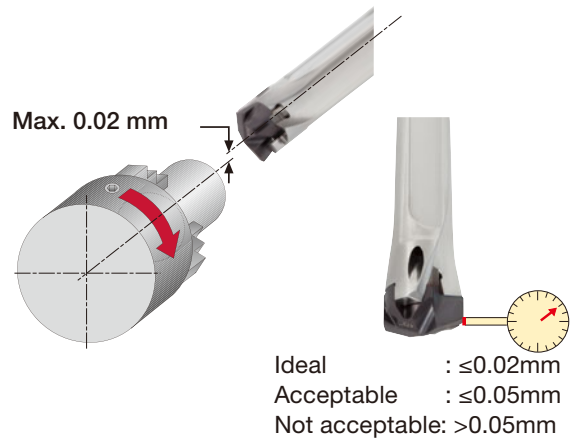

INSTRUCTION OF CLAMPING HEAD

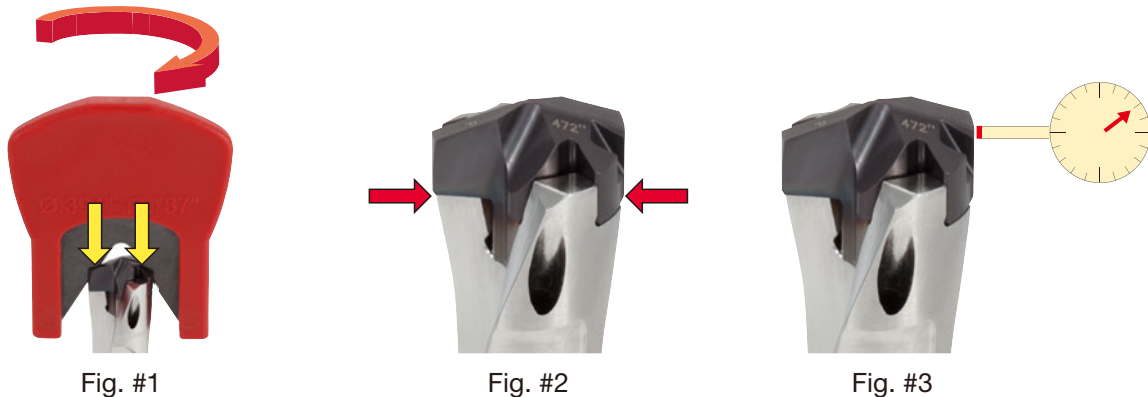

Procedure

- ① Clean the clamping areas on the drill body and the head with an air blast, lubricate them, and put the drill head in the pocket.
- ② Set the clamping key in the groove on the drill head. Push the head toward the pocket with equal torque on the right and the left sides, and turn the clamping key to clamp the head completely. (Fig. #1)
- ③ Be sure that there is no gap between the bottom of the head and the drill body. A shim in the thickness of around 0.01 mm is useful to check the gap. (Fig. #2)
- ④ If there is a gap thicker than 0.01 mm, unclamp the head and return to procedure No. ①
- ⑤ Check the run-out at the margin of the drill head. Run-out must be less than 0.05 mm. (Fig. #3) (Recommended value: less than 0.02 mm)
 If the run-out exceeds 0.05 mm, unclamp the head and return to procedure No. ①.

Note #1: If the clamping torque is not equally applied on the right and the left sides of the drill head, there may be a gap between the head and the body, which increases the run-out of the head.

Note #2: Low accuracy in holding the drill body may affect the run-out. If the run-out is large, check the accuracy in holding the drill body.

CAUTION FOR USING DRILLS WITH L/D = 8 & 12

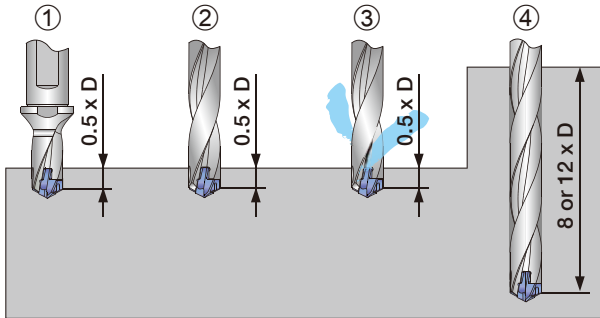

- ① Drill a pilot hole in the depth of 0.5 x D.
- ② Rotate the drill at a low speed, such as 100 min⁻¹, and feed it slowly into the pilot hole until the drill reaches several millimeters from the bottom.
- ③ Supply the coolant and rotate the drill at the recommended speed.
- ④ Drill the required depth under the recommended cutting conditions.

Use the DMC drill head when using a long overhang drill (8xD-12xD) without a pilot hole.

HOLDERS RECOMMENDED FOR M/C

First recommendation



Power chuck



Collet chuck



Side lock

Note: If you need to use a 12xD body with a side-lock holder, the shank will need to have a flat area which may be placed additionally.

CLAMPING KEY FOR MEASURING UN-CLAMPING TORQUE

To check drill body duration, measure un-clamping torque by using a torque-driver
Recommended value of un-clamping torque that means usable limit of a drill body shown in below table.

Clamping key for measuring un-clamping torque:
KHS-TID10-19.99









* The clamping key can be connect with general torque drivers.

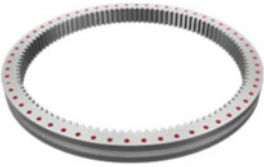

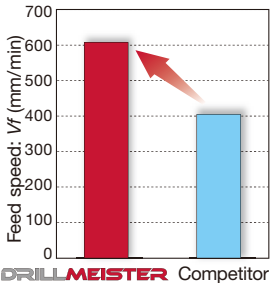
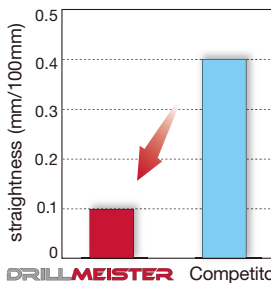

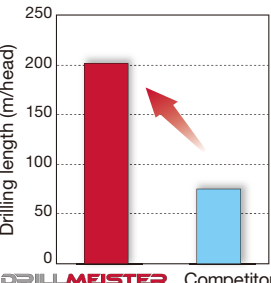
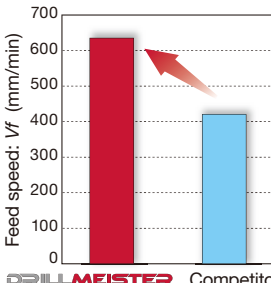
Head Designation	Recommended value of un-clamping torque that means usable limit of a drill body	
	(N·m)	(cN·m)
DM*100-109	0.2	20
DM*110-119	0.2	20
DM*120-129	0.25	25
DM*130-139	0.25	25
DM*140-149	0.3	30
DM*150-159	0.3	30
DM*160-169	0.35	35
DM*170-179	0.35	35
DM*180-189	0.4	40
DM*190-199	0.4	40

PRACTICAL EXAMPLES

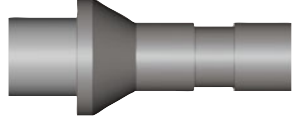

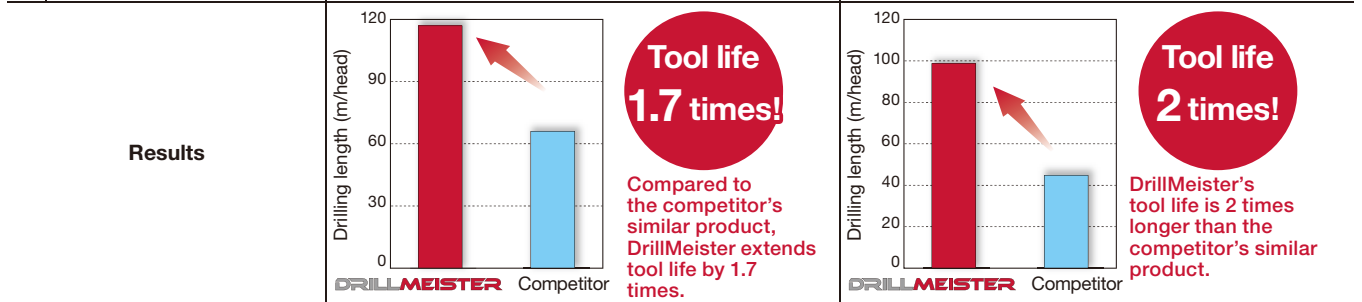

Workpiece type		Slewing ring	Out put shaft
Drill body		TID140F16-5	TID140F16-8
Head		DMC140 AH9130	DMC140 AH9130
Workpiece material		SCM440 / 42CrMo4	SCM415 / Low carbon alloy
		 P	 P
Cutting conditions	Cutting speed: V_c (m/min)	90	120
	Feed : f (mm/rev)	0.3	0.3
	Feed speed : V_f (mm/min)	600	600
	Drill diameter : ϕD_c (mm)	14	14
	Hole depth : H (mm)	60	80
	Machine	Vertical M/C	Horizontal M/C
	Coolant	Wet (Internal)	Wet (Internal)
Results	 Productivity 1.5 times! Irregular hole diameters was an issue with competitor's drill. DrillMeister's DMC drill head was able to drill highly accurate hole diameters.	 Improved straightness With the competitor's drill, the hole quality could not satisfy the straightness required. DrillMeister's DMC drill head improved the hole straightness to 1/4 of the competitor's.	
	DRILLMEISTER Competitor	DRILLMEISTER Competitor	
Workpiece type		Wheel hub	Brake disk
Drill body		TID135F16-3	TID125F16-3
Head		DMP138 AH9130	DMP126 AH725
Workpiece material		S50C / C55	FC250 / 250
		 P	 K
Cutting conditions	Cutting speed: V_c (m/min)	90	100
	Feed : f (mm/rev)	0.2	0.2
	Feed speed : V_f (mm/min)	412	633
	Drill diameter : ϕD_c (mm)	13.8	12.6
	Hole depth : H (mm)	15	6
	Machine	Horizontal M/C	Vertical M/C
	Coolant	Wet (External)	Wet (External)
Results	 Tool life 3 times! AH9130 grade with high fracture resistance extends tool life by 3 times compared to the competitor.	 Productivity 1.5 times! As DrillMeister allows machining at high feed, the productivity is increased by 1.5 times and the tool life is tripled compared to the competitor.	
	DRILLMEISTER Competitor	DRILLMEISTER Competitor	

Workpiece type	Out put shaft	Drive pinion shaft	
Drill body	TIDC160C16-5	TID160F20-5	
Head	DMP165 AH9130	DMP160 AH9130	
	SCr420 / 20Cr4	SCM415 / Low carbon alloy	
Workpiece material	 P	 P	
Cutting conditions	Cutting speed: V_c (m/min)	80	110
	Feed : f (mm/rev)	0.18	0.25
	Feed speed : V_f (mm/min)	292	547
	Drill diameter : ϕD_c (mm)	15.7	16
	Hole depth : H (mm)	30	72.2
	Machine	Vertical M/C	NC lathe
Coolant	Wet (Internal)	Wet (Internal)	

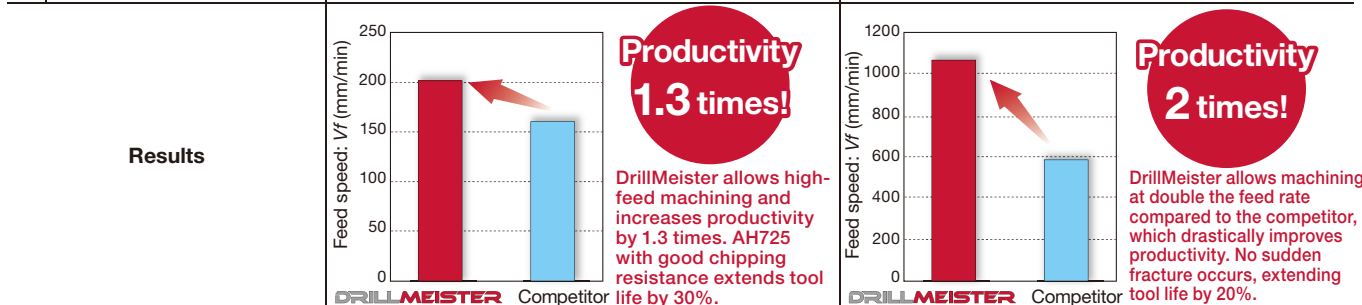

Workpiece type	Ball valve	Ring gear	
Drill body	TIDC100C10-3	TIDC100C10-3	
Head	DMP105 AH725	DMP100 AH725	
	SUS304 / X5CrNi18-9	SCM440 / 42CrMo4	
Workpiece material	 M	 P	
Cutting conditions	Cutting speed: V_c (m/min)	45	122
	Feed : f (mm/rev)	0.15	0.28
	Feed speed : V_f (mm/min)	200	1050
	Drill diameter : ϕD_c (mm)	10.5	10
	Hole depth : H (mm)	23	35
	Machine	Horizontal M/C	Vertical M/C
Coolant	Wet (Internal supply)	Wet (Internal supply)	

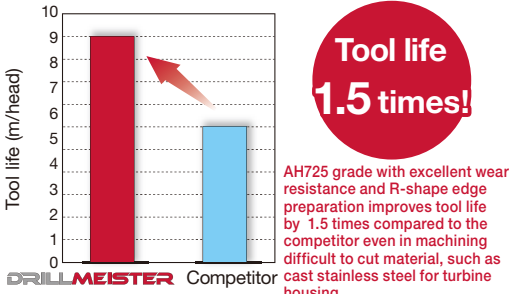
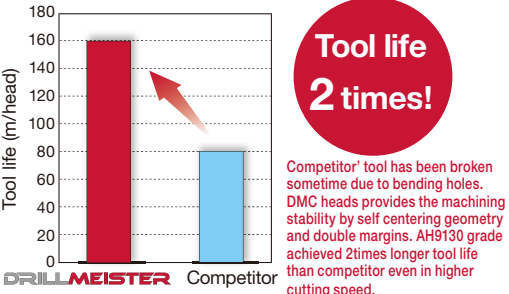
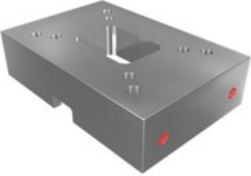

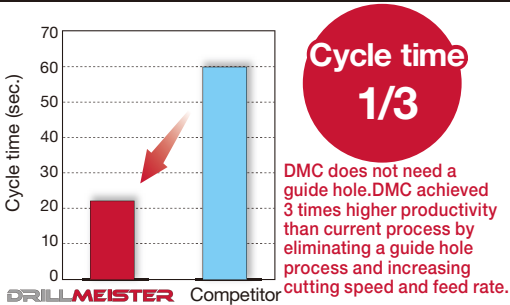
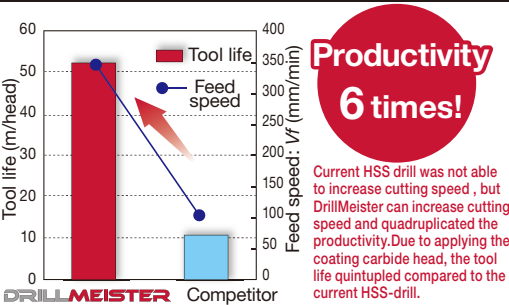
Workpiece type		Turbine housing	Cylinder block
Drill body		TID100F16-3	TID115F16-8
Head		DMP106 AH725	DMC115 AH9130
		1.4848	FC250 / 250
Workpiece material		 M	 K
Cutting conditions	Cutting speed: V_c (m/min)	65	100
	Feed : f (mm/rev)	0.15	0.2
	Feed speed : V_f (mm/min)	277	554
	Hole diameter: ϕD_c (mm)	10.6	11.5
	Hole depth : H (mm)	10	80
	Machine	Vertical M/C	Horizontal M/C
	Coolant	Internal	Internal
Results			
	<p>Tool life 1.5 times!</p> <p>AH725 grade with excellent wear resistance and R-shape edge preparation improves tool life by 1.5 times compared to the competitor even in machining difficult to cut material, such as cast stainless steel for turbine housing.</p>	<p>Tool life 2 times!</p> <p>Competitor* tool has been broken sometime due to bending holes. DMC heads provides the machining stability by self centering geometry and double margins. AH9130 grade achieved 2times longer tool life than competitor even in higher cutting speed.</p>	
Workpiece type		Mold base	Tie rod
Drill body		TID180R25-12	TID105F16-5
Head		DMC180 AH9130	DMP107 AH725
		S55C / C55	S35C / C35
Workpiece material		 P	 P
Cutting conditions	Cutting speed: V_c (m/min)	120	60
	Feed : f (mm/rev)	0.25	0.2
	Feed speed : V_f (mm/min)	531	357
	Hole diameter: ϕD_c (mm)	18	10.7
	Hole depth : H (mm)	200	35
	Machine	Horizontal M/C	Vertical M/C
Coolant	Internal	Internal	
Results			
	<p>Cycle time 1/3</p> <p>DMC does not need a guide hole. DMC achieved 3 times higher productivity than current process by eliminating a guide hole process and increasing cutting speed and feed rate.</p>	<p>Productivity 6 times!</p> <p>Current HSS drill was not able to increase cutting speed, but DrillMeister can increase cutting speed and quadruplicated the productivity. Due to applying the coating carbide head, the tool life quintupled compared to the current HSS-drill.</p>	

MEMO

A large grid of graph paper for taking notes, consisting of 20 columns and 30 rows of small squares.

Check our site and our App to get more info!

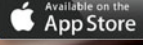
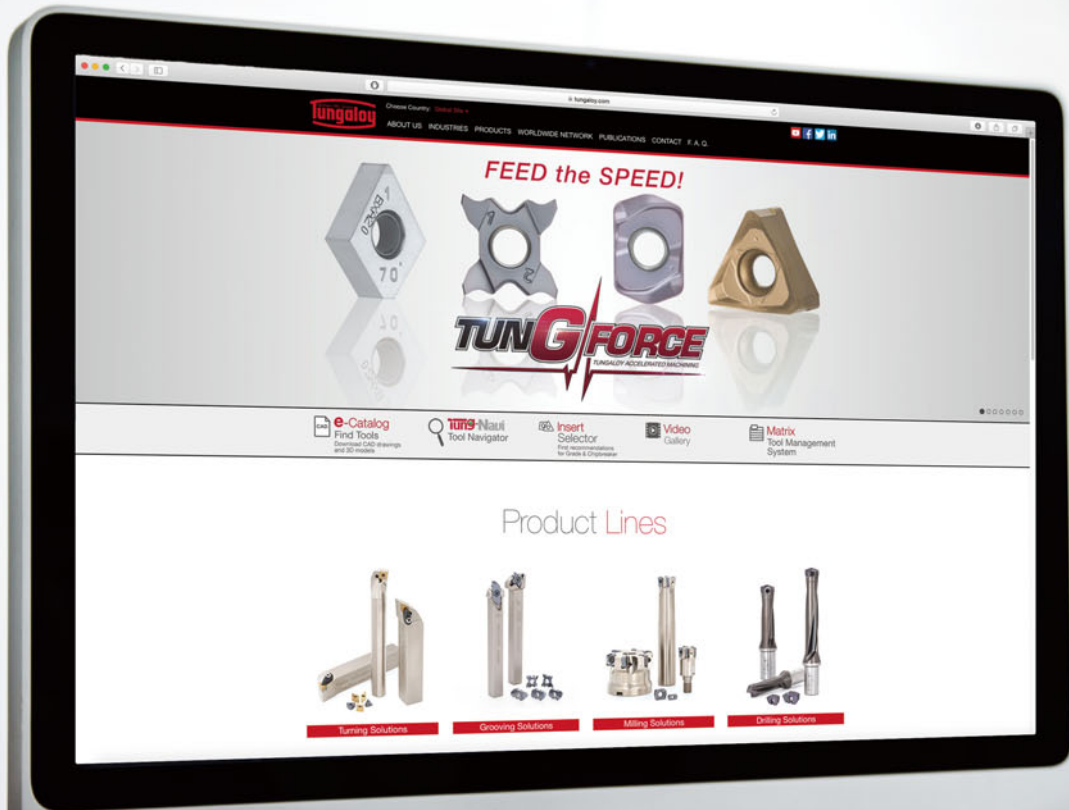

Tungaloy Corporation (Head office)

11-1 Yoshima-Kogyodanchi
Iwaki-city, Fukushima 970-1144 Japan
Phone: +81-246-36-8501
Fax: +81-246-36-8542
www.tungaloy.co.jp

Tungaloy America, Inc.

3726 N Ventura Drive
Arlington Heights, IL 60004, U.S.A.
Phone: +1-888-554-8394
Fax: +1-888-554-8392
www.tungaloy.com/us

Tungaloy Canada

432 Elgin St. Unit 3
Brantford, Ontario N3S 7P7, Canada
Phone: +1-519-758-5779
Fax: +1-519-758-5791
www.tungaloy.com/ca

Tungaloy de Mexico S.A.

C Los Arellano 113,
Parque Industrial Siglo XXI
Aguascalientes, AGS, Mexico 20290
Phone: +52-449-929-5410
Fax: +52-449-929-5411
www.tungaloy.com/mx

Tungaloy do Brasil Ltda.

Avd. Independencia N4158 Residencial Flora
13280-000 Vinhedo, São Paulo, Brasil
Phone: +55-19-38262757
Fax: +55-19-38262757
www.tungaloy.com/br

Tungaloy Germany GmbH

An der Alten Ziegelei 1
D-40789 Monheim, Germany
Phone: +49-2173-90420-0
Fax: +49-2173-90420-19
www.tungaloy.de

Tungaloy France S.A.S.

ZA Courtaboef - Le Rio
1 rue de la Terre de feu
F-91952 Courtaboef Cedex, France
Phone: +33-1-6486-4300
Fax: +33-1-6907-7817
www.tungaloy.com/fr

Tungaloy Italia S.r.l.

Via E. Andolfato 10
I-20126 Milano, Italy
Phone: +39-02-252012-1
Fax: +39-02-252012-65
www.tungaloy.com/it

Tungaloy Czech s.r.o.

Turanka 115
CZ-627 00 Brno, Czech Republic
Phone: +420-532 123 391
Fax: +420-532 123 392
www.tungaloy.com/cz

Tungaloy Ibérica S.L.

C/Miquel Servet, 43B, Nau 7
Pol. Ind. Bufalvent
ES-08243 Manresa (BCN), Spain
Phone: +34 93 113 1360
Fax: +34 93 876 2798
www.tungaloy.com/es

Tungaloy Scandinavia AB

Bultgatan 38
442 40 Kungälv, Sweden
Phone: +46-462119200
Fax: +46-462119207
www.tungaloy.com/se

Tungaloy Rus, LLC

Andropova avenue, h.18/7,
11 floor, office 3, 115432,
Moscow, Russia
Phone: +7-499-683-01-80
Fax: +7-499-683-01-81
www.tungaloy.com/ru

Tungaloy Polska Sp. z o.o.

Ul. Iryszowa 1, 55-040 Bielany
Wroclawskie, Poland
Phone: +48 607 907 237
www.tungaloy.com/pl

Tungaloy U.K. Ltd

Gallan Park, Watling Street,
Cannock, WS110XG, UK
Phone: +44 121 4000 231
Fax: +44 121 270 9694
www.tungaloy.com/uk

Tungaloy Hungary Kft

Erzsébet királyné útja 125
H-1142 Budapest, Hungary
Phone: +36 1 781-6846
Fax: +36 1 781-6866
www.tungaloy.com/hu

Tungaloy Turkey

Dudullu, OSB 4. Cad No:4
34776 Umraniye Istanbul, TURKEY
Phone: +90 216 540 04 67
Fax: +90 216 540 04 87
www.tungaloy.com/tr

Tungaloy Benelux b.v.

Tjalk 70
NL-2411 NZ Bodegraven, Netherlands
Phone: +31 172 630 420
Fax: +31 172 630 429
www.tungaloy.com/nl

Tungaloy Croatia

Ulica bana Josipa Jelačića 87,
10430, Samobor, Croatia
Phone: +385 1 3326 604
Fax: +385 1 3327 683
www.tungaloy.com/hr

Tungaloy Cutting Tool (Shanghai) Co., Ltd.

Rm No 401 No.88 Zhabei
Jiangchang No.3 Rd
Shanghai 200436, China
Phone: +86-21-3632-1880
Fax: +86-21-3621-1918
www.tungaloy.com/cn

Tungaloy Cutting Tools (Taiwan) Co., Ltd.

9F, No.293, Zhongyang Rd,
Xinzhuan Dist, New Taipei City,
24251 Taiwan
Phone: +886-2-8521-9986
Fax: +886-2-8521-8935
www.tungaloy.com/tw

Tungaloy Cutting Tools (Thailand) Co., Ltd.

Interlink tower 4th Fl.
1858/5-7 Bangna-Trad Road
km.5 Bangna, Bangna, Bangkok 10260
Thailand
Phone: +66-2-751-5711
Fax: +66-2-751-5715
www.tungaloy.com/th

Tungaloy Singapore (Pte.), Ltd.

62 Ubi Road 1, #06-11 Oxley BizHub 2
Singapore 408734
Phone: +65-6391-1833
Fax: +65-6299-4557
www.tungaloy.com/sg

Tungaloy Vietnam

LE04.38, Lexington Residence
67 Mai Chi Tho St., Dist. 2,
Ho Chi Minh City, Vietnam
Phone: +84-2837406660
www.tungaloy.com/sg

Tungaloy India Pvt. Ltd.

Indiabulls Finance Centre,
Unit # 902-A, 9th Floor,
Tower 1, Senapati Bapat Marg,
Elphinstone Road (West),
Mumbai-400013, India
Phone: +91-22-6124-8804
Fax: +91-22-6124-8899
www.tungaloy.com/in

Tungaloy Korea Co., Ltd

#1312, Byucksan Digital Valley 5-cha
Beotkkot-ro 244, Geumcheon-gu
153-788 Seoul, Korea
Phone: +82-2-2621-6161
Fax: +82-2-6393-8952
www.tungaloy.com/kr

Tungaloy Malaysia Sdn Bhd

50 K-2, Kelana Mall, Jalan SS6/14
Kelana Jaya, 47301
Petaling Jaya, Selangor Darul Ehsan
Malaysia
Phone: +603-7805-3222
Fax: +603-7804-8563
www.tungaloy.com/my

Tungaloy Australia Pty Ltd

Unit 68 1470 Ferntree Gully Road
Knoxfield 3180 Victoria, Australia
Phone: +61-3-9755-8147
Fax: +61-3-9755-6070
www.tungaloy.com/au

PT. Tungaloy Indonesia

Kompleks Grand Wisata Block AA-10 No.3-5
Cibitung
Bekasi 17510, Indonesia
Phone: +62-21-8261-5808
Fax: +62-21-8261-5809
www.tungaloy.com/id



www.tungaloy.com

follow us at:

facebook.com/tungaloyjapan

twitter.com/tungaloyjapan

www.youtube.com/tungaloycorporation



AS9100 Certified
78006
2015.11.04
ISO14001 Certified
EC97J1123
1997.11.26

Distributed by:



FIND US ON THE CLOUD!
machiningcloud.com

